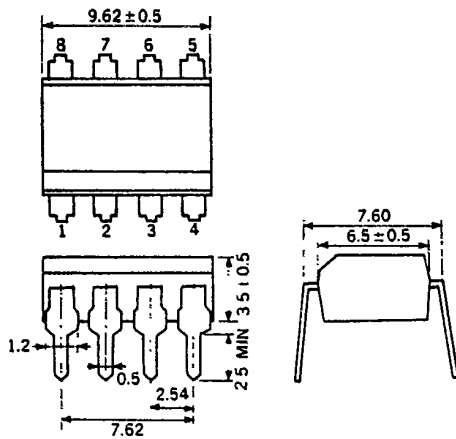

PHOTO COUPLER PS2044

HIGH SPEED 8PIN PHOTO COUPLER

PACKAGE DIMENSIONS (Unit: mm)



PIN CONNECTION

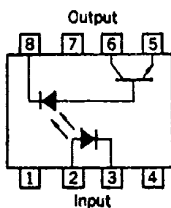

PIN	Function
1.	NC
2.	Anode
3.	Cathode
4.	NC
5.	Emitter
6.	V _O
7.	NC
8.	V _{CC}

FEATURES

- High Speed Response 0.3 μs TYP.
- High Isolation Voltage 2500 V_{r.m.s.}
- Compact, Dual In-Line Package

APPLICATIONS

1. Interface circuit for various instrumentations, control equipments.
2. Computer and peripheral manufactures.
3. TV sets.

ABSOLUTE MAXIMUM RATINGS (T_a = 25 °C)

Diode

Forward Current	I _F	25	mA
Reverse Voltage	V _R	5	V
Power Dissipation	P _D	45	mW

Detector

Supply Voltage	V _{CC}	-0.5 to 15	V
Output Voltage	V _O	-0.5 to 15	V
Output Current	I _O	8	mA
Power Dissipation	P _C	100	mW
Isolation Voltage*	BV	2500	V _{r.m.s.}
Storage Temperature	T _{stg}	-55 to +125	°C
Operating Temperature	T _{opt}	-55 to +100	°C
Lead Temperature (10 s)		260	°C

* Condition

AC Voltage for 1 minute at T_a = 25 °C, RH = 60 %
between input (pin No. 1, 2, 3, 4 Common) and output (pin No. 5, 6, 7, 8 Common)

PS2044

T-41-83

ELECTRICAL CHARACTERISTICS (T_a = 25 °C)

CHARACTERISTIC		SYMBOL	MIN.	TYP.	MAX.	UNIT	TEST CONDITIONS
Diode	Forward Voltage	V _F		1.7	2.2	V	I _F = 16 mA
	Reverse Current	I _R		0.01	10	μA	V _R = 5 V
	Forward Voltage Temperature Coefficient	$\frac{\Delta V_F}{\Delta T}$		-1.6		mV/°C	I _F = 16 mA
	Capacitance	C _t		60		pF	V = 0, f = 1 MHz
Detector	High Level Output Current	I _{OH} (1)		3	500	nA	I _F = 0 mA, V _{CC} = V _O = 5.5 V
	High Level Output Current	I _{OH} (2)			100	μA	I _F = 0 mA, V _{CC} = V _O = 15 V
Coupled	Current Transfer Ratio	CTR *	15	22		%	I _F = 16 mA, V _{CC} = 4.5 V, V _O = 0.4 V
	Low Level Output Voltage	V _{OL}		0.1	0.4	V	I _F = 16 mA, V _{CC} = 4.5 V, I _O = 2.4 mA
	Low Level Supply Current	I _{CC} L		50		μA	I _F = 16 mA, V _O = Open, V _{CC} = 15 V
	High Level Supply Current	I _{CC} H		0.01	1	μA	I _F = 0 mA, V _O = Open, V _{CC} = 15 V
	Isolation Resistance	R ₁₋₂	10 ¹¹			Ω	V _{in-out} = 1 kVDC
	Isolation Capacitance	C ₁₋₂		0.7		pF	V = 0, f = 1 MHz
	Propagation Delay Time to Low Output Level	t _{PHL} **		0.3	0.8	μs	I _F = 16 mA, V _{CC} = 5 V, R _L = 1.9 kΩ
	Propagation Delay Time to High Output Level	t _{PLH} **		(K/L/R) 0.3/1.0/0.8	(K/L/R) 0.8/1.5/1.25	μs	I _F = 16 mA, V _{CC} = 5 V, R _L = 1.9 kΩ

- CTR rank
 K: 15% ~
 L: 25% ~
 R: 20% ~

** Measuring circuit

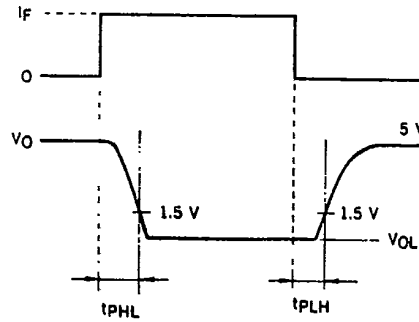
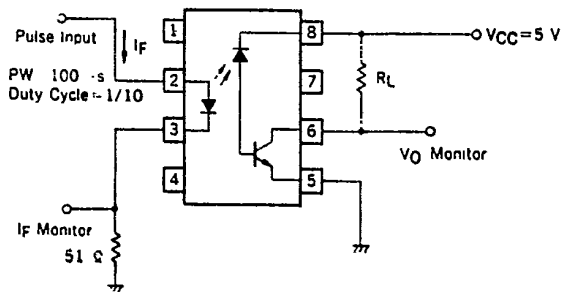

TYPICAL CHARACTERISTICS ($T_a = 25^\circ\text{C}$)

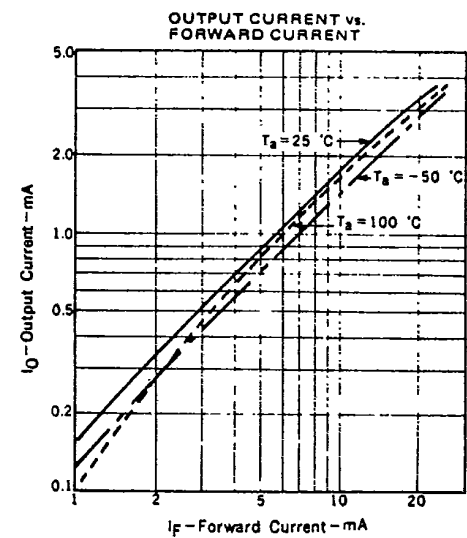
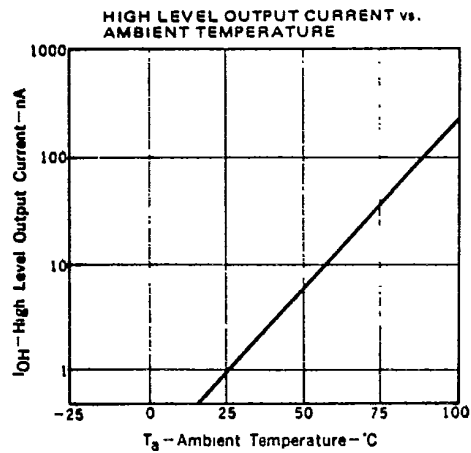
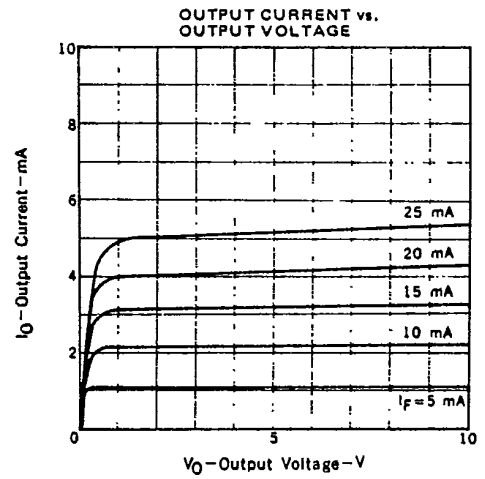
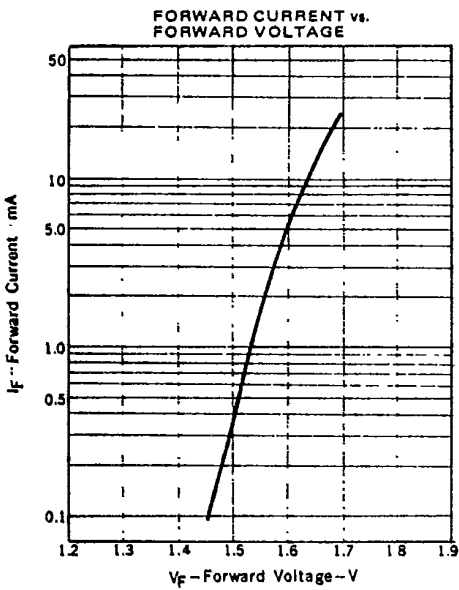
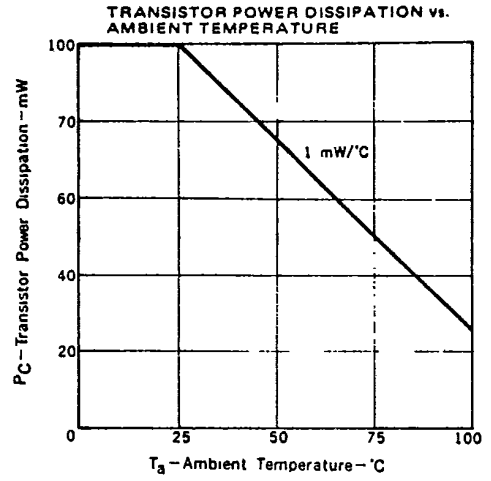
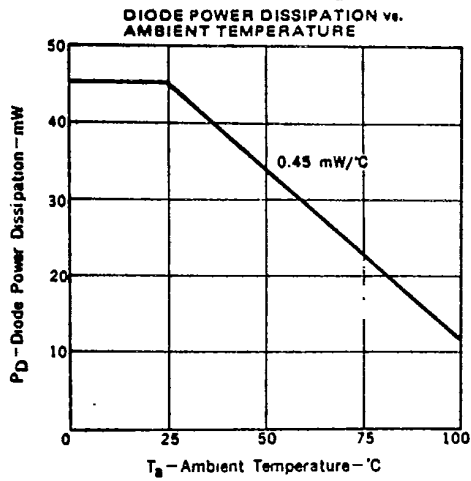

PS2044

T-41-83

