

IRF7341Q

HEXFET[®] Power MOSFET

Typical Applications

- Anti-lock Braking Systems (ABS)
- Electronic Fuel Injection
- Air bag

Benefits

- Advanced Process Technology
- Dual N-Channel MOSFET
- Ultra Low On-Resistance
- 175°C Operating Temperature
- Repetitive Avalanche Allowed up to Tjmax
- Automotive [Q101] Qualified

V _{DSS}	R _{DS(on)} max	I _D
55V	0.050 @ V _{GS} = 10V	5.1A
	0.065 @ V _{GS} = 4.5V	4.42A

Description

Specifically designed for Automotive applications, these HEXFET[®] Power MOSFET's in a Dual SO-8 package utilize the latest processing techniques to achieve extremely low on-resistance per silicon area. Additional features of these Automotive qualified HEXFET Power MOSFET's are a 175°C junction operating temperature, fast switching speed and improved repetitive avalanche rating. These benefits combine to make this design an extremely efficient and reliable device for use in Automotive applications and a wide variety of other applications.

The 175°C rating for the SO-8 package provides improved thermal performance with increased safe operating area and dual MOSFET die capability make it ideal in a variety of power applications. This dual, surface mount SO-8 can dramatically reduce board space and is also available in Tape & Reel.

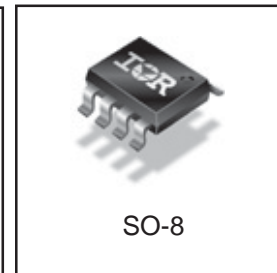
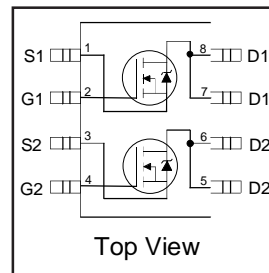

Absolute Maximum Ratings

	Parameter	Max.	Units
V _{DS}	Drain-Source Voltage	55	V
I _D @ T _A = 25°C	Continuous Drain Current, V _{GS} @ 10V	5.1	A
I _D @ T _A = 70°C	Continuous Drain Current, V _{GS} @ 10V	4.2	
I _{DM}	Pulsed Drain Current ^①	42	
P _D @ T _A = 25°C	Maximum Power Dissipation ^③	2.4	W
P _D @ T _A = 70°C	Maximum Power Dissipation ^③	1.7	W
	Linear Derating Factor	16	mW/°C
V _{GS}	Gate-to-Source Voltage	± 20	V
E _{AS}	Single Pulse Avalanche Energy ^②	140	mJ
I _{AR}	Avalanche Current ^①	5.1	A
E _{AR}	Repetitive Avalanche Energy	See Fig. 14, 15, 16	mJ
T _J , T _{STG}	Junction and Storage Temperature Range	-55 to + 175	°C

Thermal Resistance

	Parameter	Max.	Units
R _{θJA}	Maximum Junction-to-Ambient ^③	62.5	°C/W

Electrical Characteristics @ T_J = 25°C (unless otherwise specified)

	Parameter	Min.	Typ.	Max.	Units	Conditions
V _{(BR)DSS}	Drain-to-Source Breakdown Voltage	55	—	—	V	V _{GS} = 0V, I _D = 250μA
ΔV _{(BR)DSS} /ΔT _J	Breakdown Voltage Temp. Coefficient	—	0.052	—	V/°C	Reference to 25°C, I _D = 1mA
R _{DS(on)}	Static Drain-to-Source On-Resistance	—	0.043	0.050	Ω	V _{GS} = 10V, I _D = 5.1A ②
		—	0.056	0.065		V _{GS} = 4.5V, I _D = 4.42A ②
V _{GS(th)}	Gate Threshold Voltage	1.0	—	—	V	V _{DS} = V _{GS} , I _D = 250μA
g _{fs}	Forward Transconductance	10.4	—	—	S	V _{DS} = 10V, I _D = 5.2A
I _{DSS}	Drain-to-Source Leakage Current	—	—	2.0	μA	V _{DS} = 44V, V _{GS} = 0V
		—	—	25		V _{DS} = 44V, V _{GS} = 0V, T _J = 150°C
I _{GSS}	Gate-to-Source Forward Leakage	—	—	100	nA	V _{GS} = 20V
	Gate-to-Source Reverse Leakage	—	—	-100		V _{GS} = -20V
Q _g	Total Gate Charge	—	29	44	nC	I _D = 5.2A
Q _{gs}	Gate-to-Source Charge	—	2.9	4.4		V _{DS} = 44V
Q _{gd}	Gate-to-Drain ("Miller") Charge	—	7.3	11		V _{GS} = 10V
t _{d(on)}	Turn-On Delay Time	—	9.2	—	ns	V _{DD} = 28V
t _r	Rise Time	—	7.7	—		I _D = 1.0A
t _{d(off)}	Turn-Off Delay Time	—	31	—		R _G = 6.0Ω
t _f	Fall Time	—	12.5	—		V _{GS} = 10V ②
C _{iss}	Input Capacitance	—	780	—	pF	V _{GS} = 0V
C _{oss}	Output Capacitance	—	190	—		V _{DS} = 25V
C _{rss}	Reverse Transfer Capacitance	—	66	—		f = 1.0MHz

Source-Drain Ratings and Characteristics

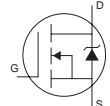
	Parameter	Min.	Typ.	Max.	Units	Conditions
I _S	Continuous Source Current (Body Diode)	—	—	2.4	A	MOSFET symbol showing the integral reverse p-n junction diode. 
I _{SM}	Pulsed Source Current (Body Diode) ①	—	—	42		
V _{SD}	Diode Forward Voltage	—	—	1.2	V	T _J = 25°C, I _S = 2.6A, V _{GS} = 0V ②
t _{rr}	Reverse Recovery Time	—	51	77	ns	T _J = 25°C, I _F = 2.6A
Q _{rr}	Reverse Recovery Charge	—	76	114	nC	di/dt = 100A/μs ②

Notes:

① Repetitive rating; pulse width limited by max. junction temperature.

② Pulse width ≤ 300μs; duty cycle ≤ 2%.

③ Surface mounted on FR-4 board, t ≤ 10sec.

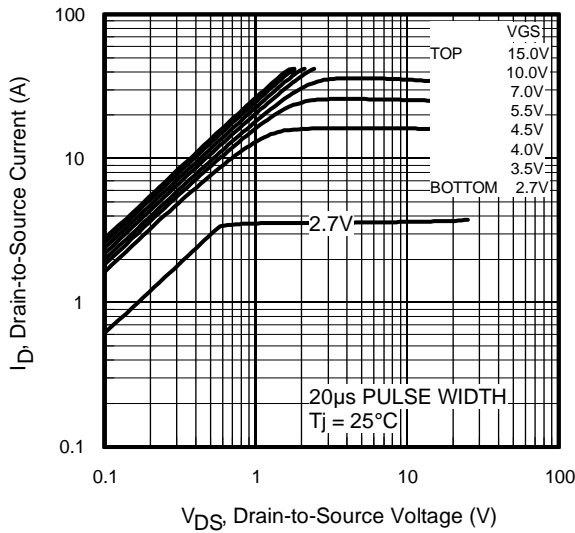

Fig 1. Typical Output Characteristics

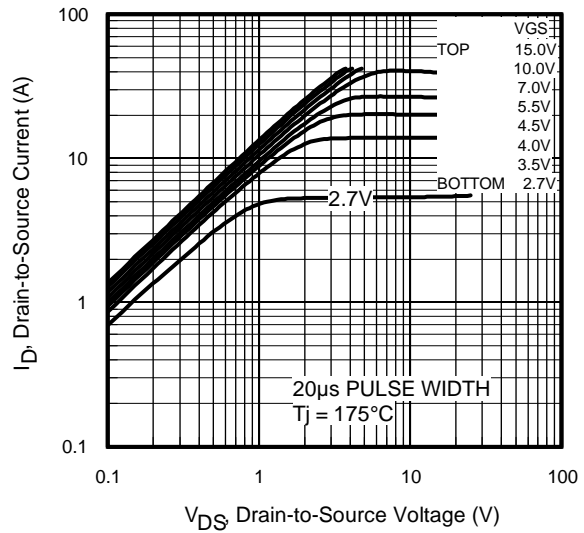

Fig 2. Typical Output Characteristics

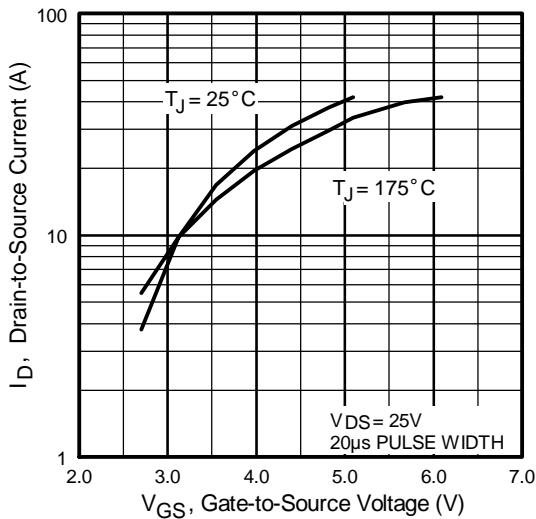

Fig 3. Typical Transfer Characteristics

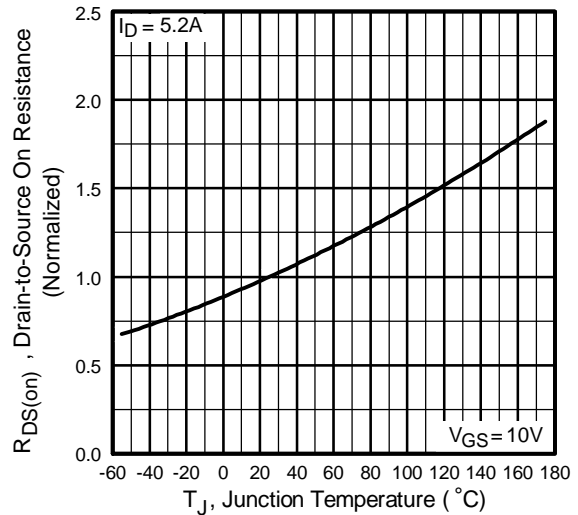

Fig 4. Normalized On-Resistance Vs. Temperature

IRF7341Q

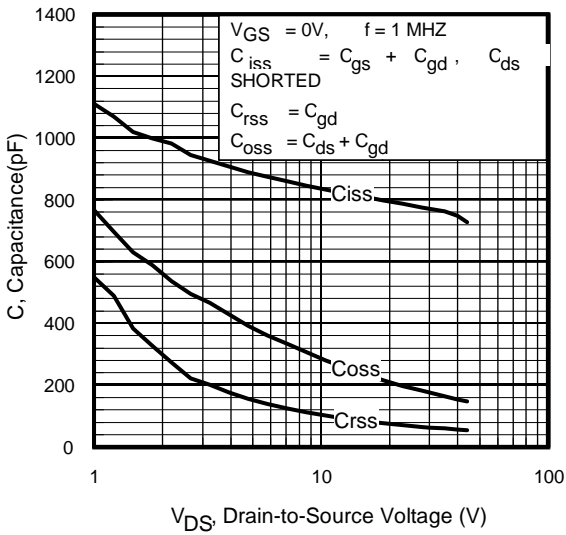

Fig 5. Typical Capacitance Vs. Drain-to-Source Voltage

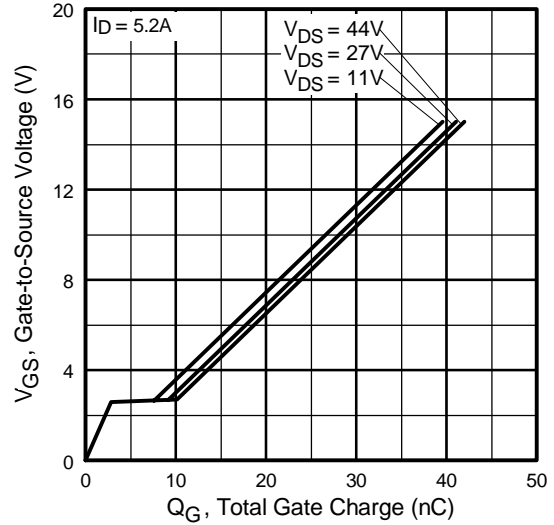

Fig 6. Typical Gate Charge Vs. Gate-to-Source Voltage

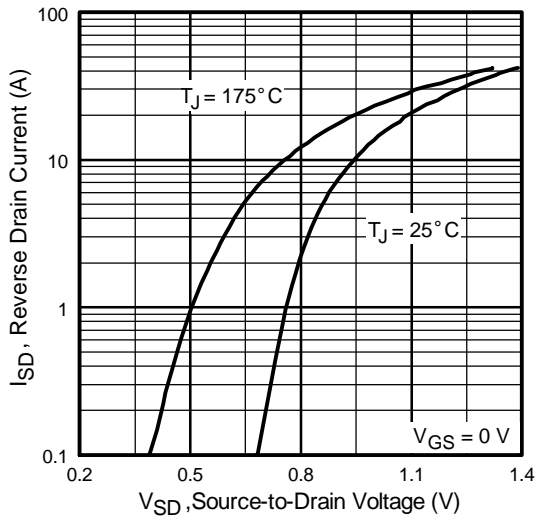

Fig 7. Typical Source-Drain Diode Forward Voltage

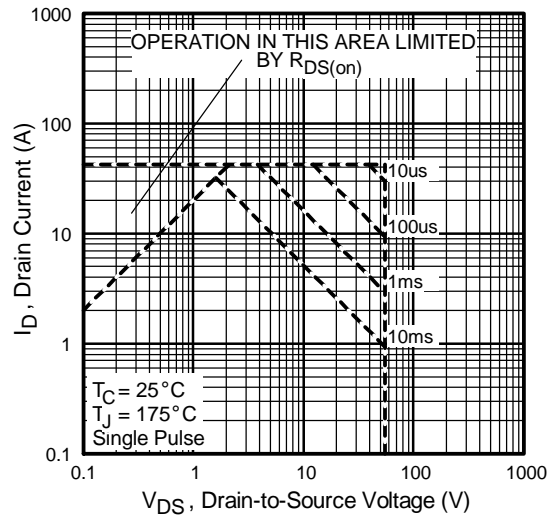

Fig 8. Maximum Safe Operating Area

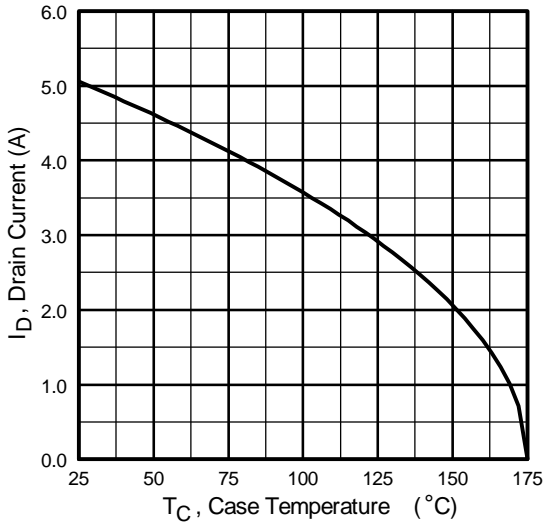

Fig 9. Maximum Drain Current Vs. Case Temperature

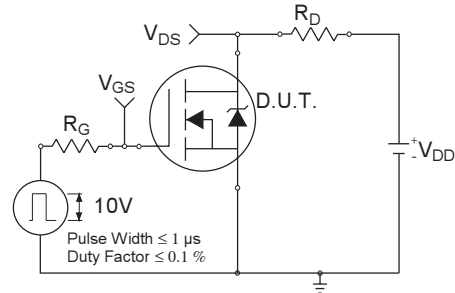

Fig 10a. Switching Time Test Circuit

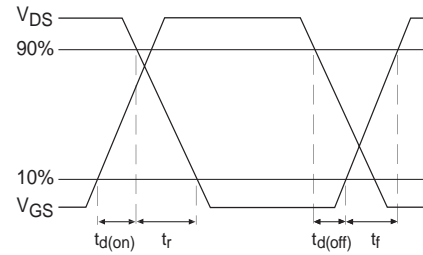

Fig 10b. Switching Time Waveforms

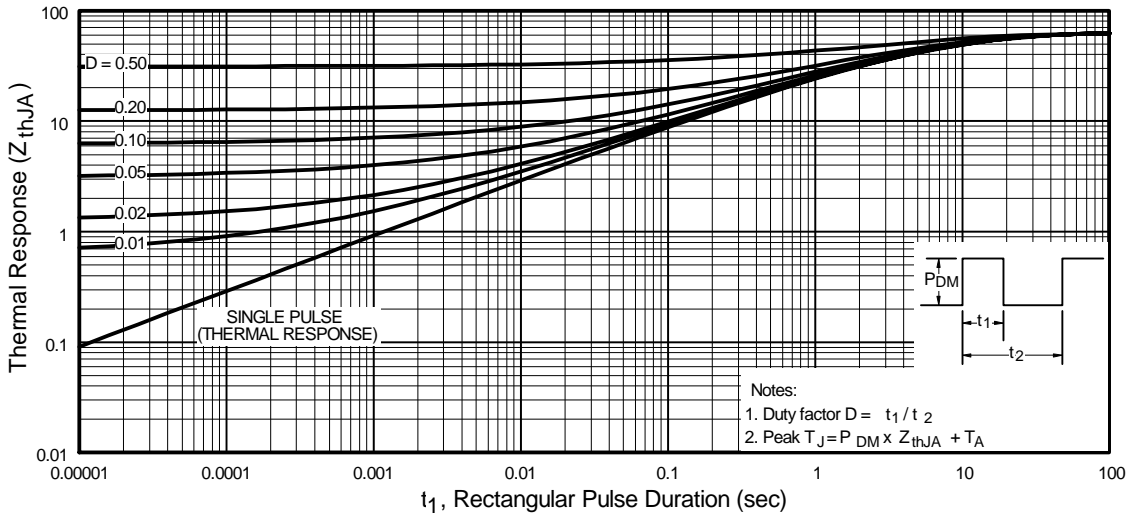

Fig 10. Maximum Effective Transient Thermal Impedance, Junction-to-Ambient

IRF7341Q

International
IR Rectifier

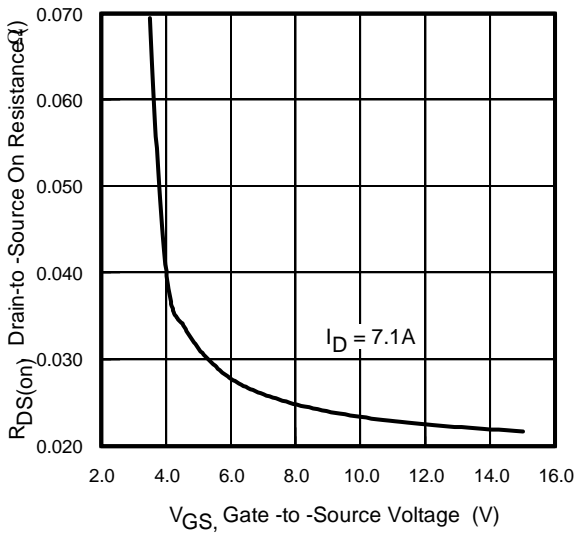

Fig 11. Typical On-Resistance Vs. Gate Voltage

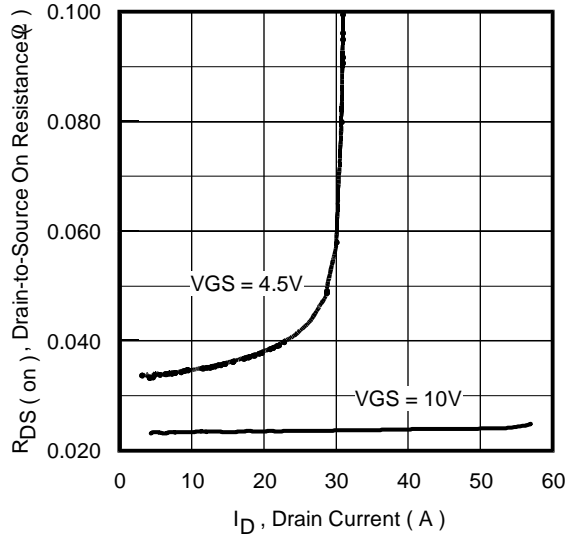

Fig 12. Typical On-Resistance Vs. Drain Current

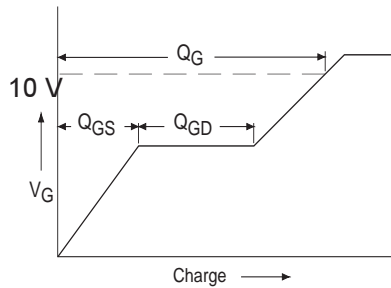

Fig 13a. Basic Gate Charge Waveform

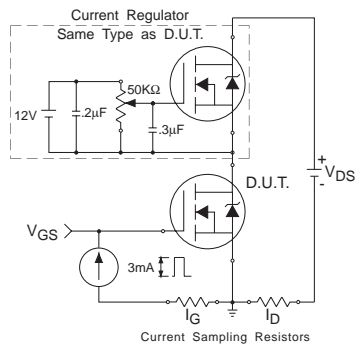

Fig 13b. Gate Charge Test Circuit

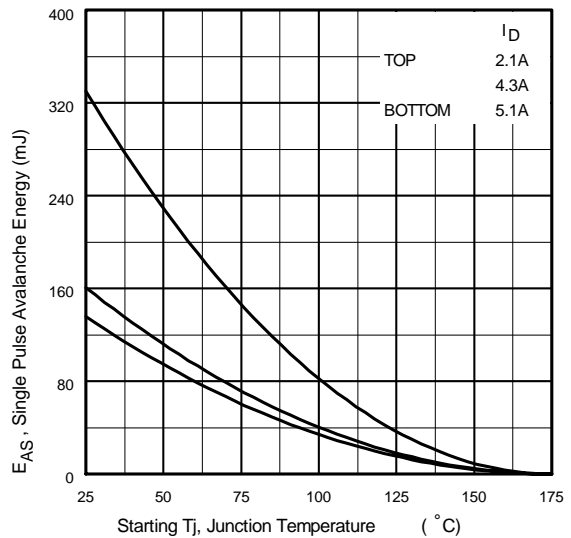

Fig 14. Maximum Avalanche Energy Vs. Drain Current

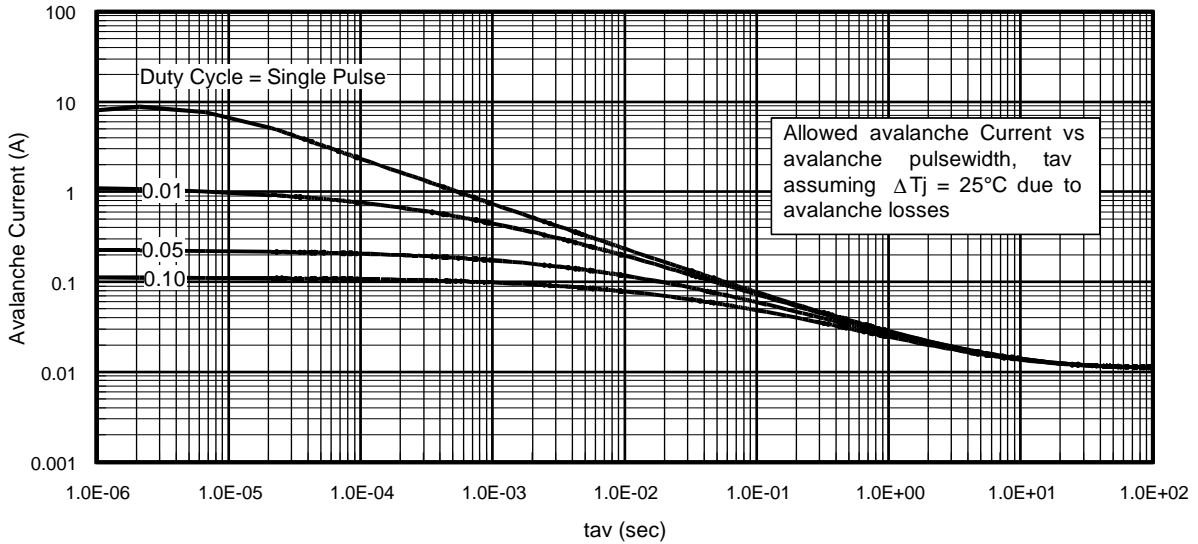

Fig 15. Typical Avalanche Current Vs.Pulsewidth

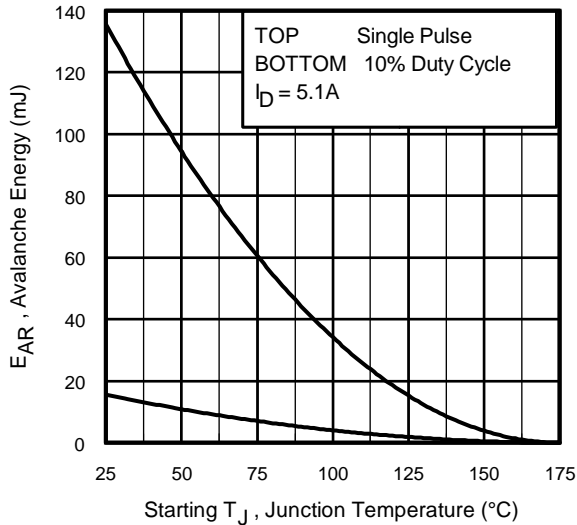

Fig 16. Maximum Avalanche Energy Vs. Temperature

**Notes on Repetitive Avalanche Curves , Figures 15, 16:
(For further info, see AN-1005 at www.irf.com)**

1. Avalanche failures assumption:
Purely a thermal phenomenon and failure occurs at a temperature far in excess of T_{jmax} . This is validated for every part type.
2. Safe operation in Avalanche is allowed as long as T_{jmax} is not exceeded.
3. Equation below based on circuit and waveforms shown in Figures 12a, 12b.
4. $P_{D(ave)}$ = Average power dissipation per single avalanche pulse.
5. BV = Rated breakdown voltage (1.3 factor accounts for voltage increase during avalanche).
6. I_{av} = Allowable avalanche current.
7. ΔT = Allowable rise in junction temperature, not to exceed T_{jmax} (assumed as 25°C in Figure 15, 16).
 t_{av} = Average time in avalanche.
 D = Duty cycle in avalanche = $t_{av} \cdot f$
 $Z_{thJC}(D, t_{av})$ = Transient thermal resistance, see figure 11)

$$P_{D(ave)} = 1/2 (1.3 \cdot BV \cdot I_{av}) = \Delta T / Z_{thJC}$$

$$I_{av} = 2 \Delta T / [1.3 \cdot BV \cdot Z_{th}]$$

$$E_{AS(AR)} = P_{D(ave)} \cdot t_{av}$$

IRF7341Q

International
IR Rectifier

SO-8 Package Outline

Dimensions are shown in millimeters (inches)

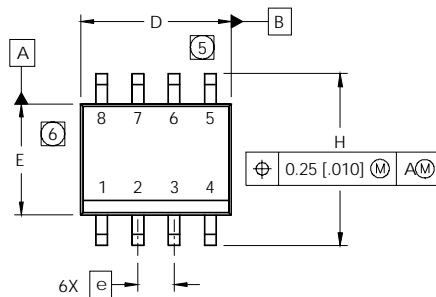

DIM	INCHES		MILLIMETERS	
	MIN	MAX	MIN	MAX
A	.0532	.0688	1.35	1.75
A1	.0040	.0098	0.10	0.25
b	.013	.020	0.33	0.51
c	.0075	.0098	0.19	0.25
D	.189	.1968	4.80	5.00
E	.1497	.1574	3.80	4.00
e	.050 BASIC		1.27 BASIC	
e1	.025 BASIC		0.635 BASIC	
H	.2284	.2440	5.80	6.20
K	.0099	.0196	0.25	0.50
L	.016	.050	0.40	1.27
y	0°	8°	0°	8°

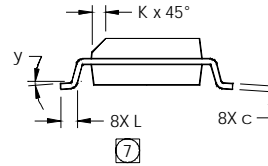
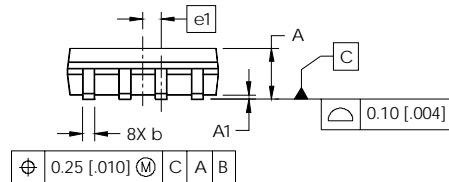

NOTES:

1. DIMENSIONING & TOLERANCING PER ASME Y14.5M-1994.
2. CONTROLLING DIMENSION: MILLIMETER
3. DIMENSIONS ARE SHOWN IN MILLIMETERS [INCHES].
4. OUTLINE CONFORMS TO JEDEC OUTLINE MS-012AA
- ⑤ DIMENSION DOES NOT INCLUDE MOLD PROTRUSIONS. MOLD PROTRUSIONS NOT TO EXCEED 0.15 [0.006].
- ⑥ DIMENSION DOES NOT INCLUDE MOLD PROTRUSIONS. MOLD PROTRUSIONS NOT TO EXCEED 0.25 [0.010].
- ⑦ DIMENSION IS THE LENGTH OF LEAD FOR SOLDERING TO A SUBSTRATE.

FOOTPRINT

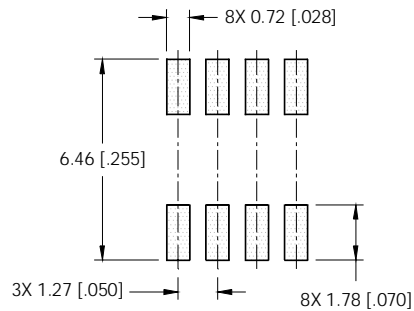

SO-8 Part Marking

EXAMPLE: THIS IS AN IRF7101 (MOSFET)

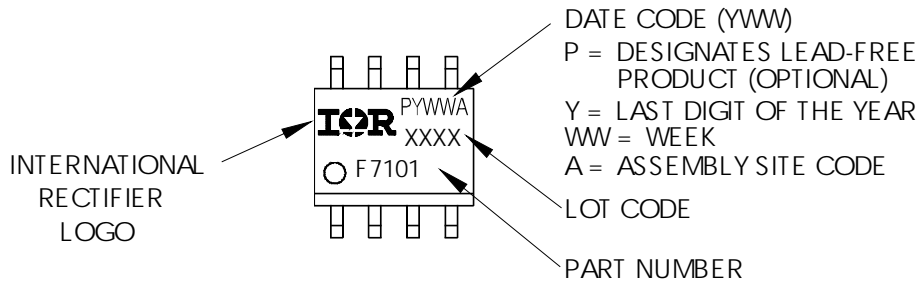

SO-8 Tape and Reel

Dimensions are shown in millimeters (inches)

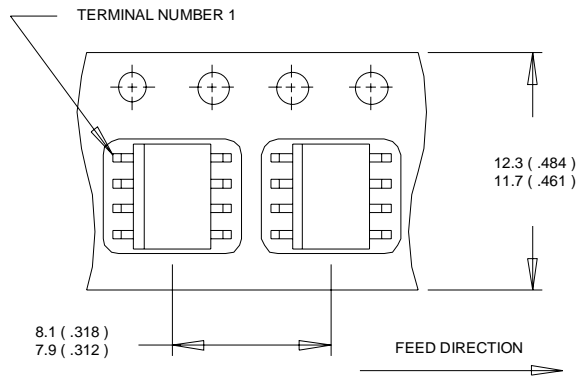

NOTES:

1. CONTROLLING DIMENSION : MILLIMETER.
2. ALL DIMENSIONS ARE SHOWN IN MILLIMETERS(INCHES).
3. OUTLINE CONFORMS TO EIA-481 & EIA-541.

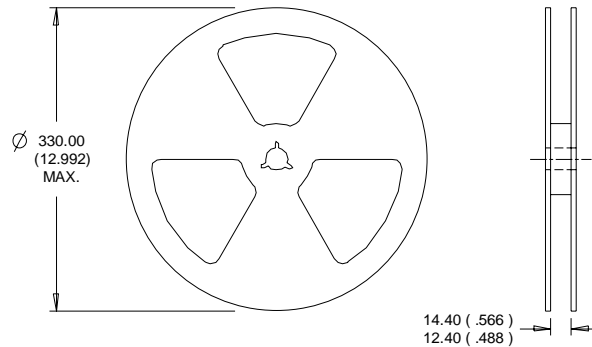

NOTES:

1. CONTROLLING DIMENSION : MILLIMETER.
2. OUTLINE CONFORMS TO EIA-481 & EIA-541.

Data and specifications subject to change without notice.
 This product has been designed and qualified for the Automotive [Q101] market.
 Qualification Standards can be found on IR's Web site.