

ELECTROSTATIC SENSITIVE DEVICE
OBSERVE HANDLING PRECAUTIONS

MITSUBISHI RF POWER MOS FET

RD20HMF1

RoHS Compliance, Silicon MOSFET Power Transistor, 900MHz, 20W

DESCRIPTION

RD20HMF1 is a MOS FET type transistor specifically designed for 900MHz-band RF power amplifiers applications.

FEATURES

High power gain:
Pout>20W, Gp>8.2dB @Vdd=12.5V, f=900MHz
High Efficiency: 55%typ.

APPLICATION

For output stage of high power amplifiers in 900MHz band
Mobile radio sets.

RoHS COMPLIANT

RD20HMF1-101 is a RoHS compliant products.
RoHS compliance is indicate by the letter "G" after the Lot Marking.

OUTLINE DRAWING

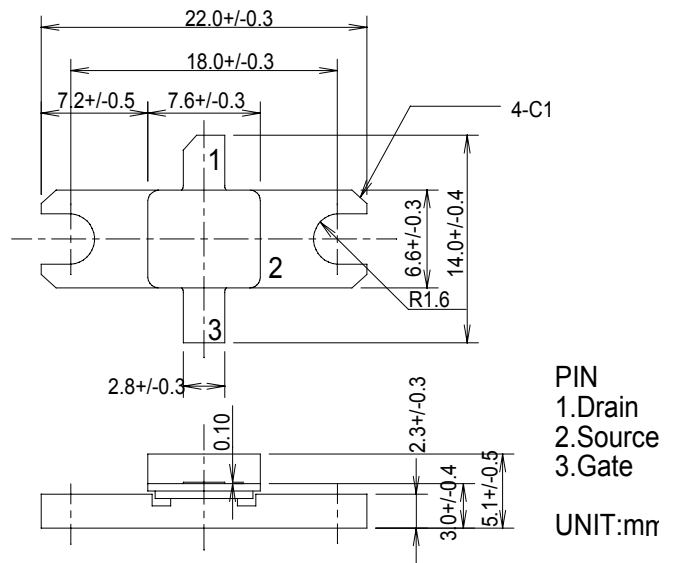

ABSOLUTE MAXIMUM RATINGS

(Tc=25°C UNLESS OTHERWISE NOTED)

SYMBOL	PARAMETER	CONDITIONS	RATINGS	UNIT
Vdss	Drain to source voltage	Vgs=0V	30	V
Vgss	Gate to source voltage	Vds=0V	+/-20	V
Pch	Channel dissipation	Tc=25°C	71.4	W
Pin	Input power	Zg=Zl=50Ω	6	W
ID	Drain current	-	6	A
Tch	Channel temperature	-	175	°C
Tstg	Storage temperature	-	-40 to +175	°C
Rth j-c	Thermal resistance	junction to case	2.1	°C/W

Note 1: Above parameters are guaranteed independently.

ELECTRICAL CHARACTERISTICS (Tc=25°C, UNLESS OTHERWISE NOTED)

SYMBOL	PARAMETER	CONDITIONS	LIMITS			UNIT
			MIN	TYP	MAX.	
Idss	Zero gate voltage drain current	VDS=17V, VGS=0V	-	-	5	uA
Igss	Gate to source leak current	VGS=10V, VDS=0V	-	-	1	uA
VTH	Gate threshold voltage	VDS=12V, Ids=1mA	1.0	-	3.0	V
Pout	Output power	f=900MHz, VDD=12.5V	20	25	-	W
ηD	Drain efficiency	Pin=3.0W, Idq=1.0A	50	55	-	%
	Load VSWR tolerance	VDD=15.2V, Po=20W(PinControl) Idq=1.0A, Zg=50Ω Load VSWR=20:1(All Phase)	No destroy			-

Note : Above parameters , ratings , limits and conditions are subject to change.



ELECTROSTATIC SENSITIVE DEVICE
OBSERVE HANDLING PRECAUTIONS

MITSUBISHI RF POWER MOS FET

RD20HMF1

RoHS Compliance, Silicon MOSFET Power Transistor, 900MHz, 20W

TYPICAL CHARACTERISTICS

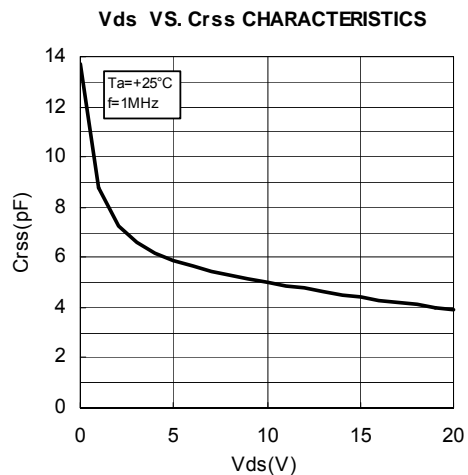
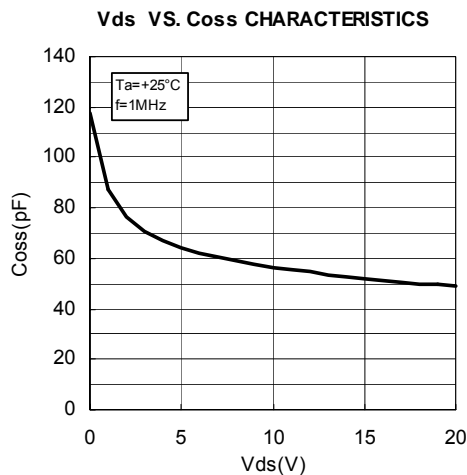
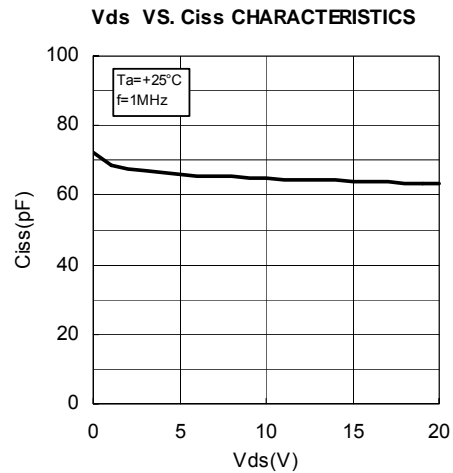
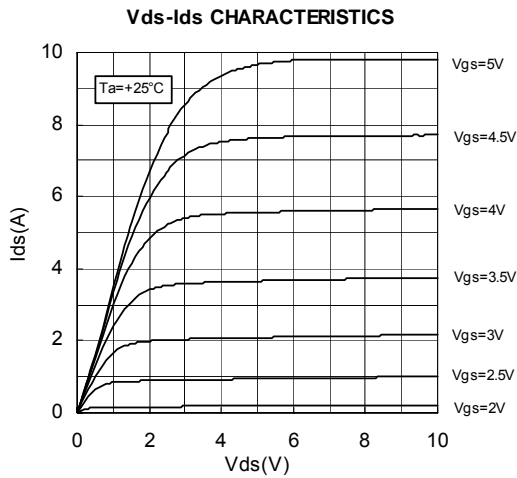
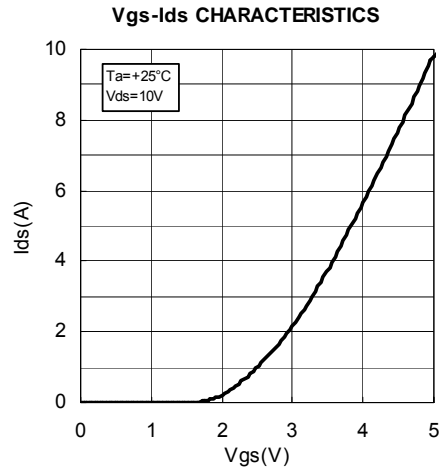
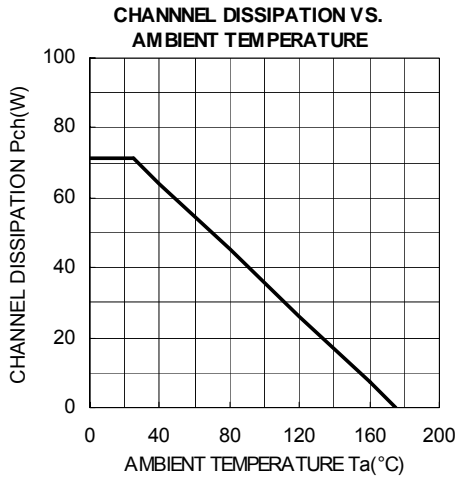



ELECTROSTATIC SENSITIVE DEVICE
OBSERVE HANDLING PRECAUTIONS

MITSUBISHI RF POWER MOS FET

RD20HMF1

RoHS Compliance, Silicon MOSFET Power Transistor, 900MHz, 20W

TYPICAL CHARACTERISTICS

Pin-Po CHARACTERISTICS

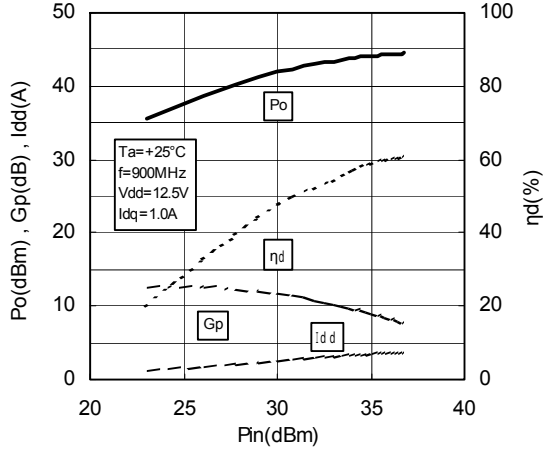

Pin-Po CHARACTERISTICS

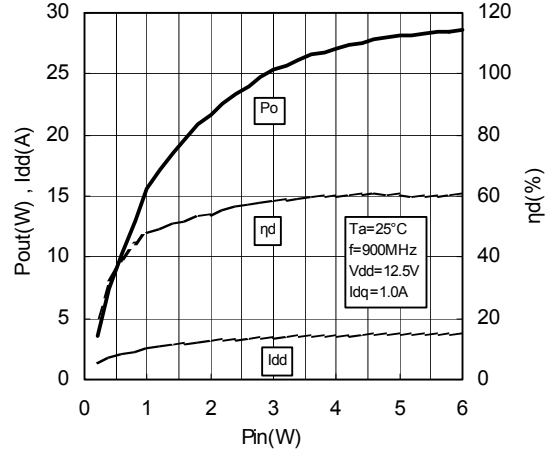

Vdd-Po CHARACTERISTICS

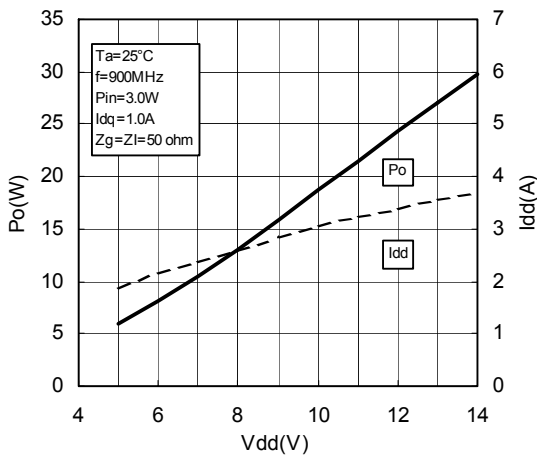



ELECTROSTATIC SENSITIVE DEVICE
OBSERVE HANDLING PRECAUTIONS

MITSUBISHI RF POWER MOS FET

RD20HMF1

RoHS Compliance, Silicon MOSFET Power Transistor, 900MHz, 20W

TEST CIRCUIT(f=900MHz)

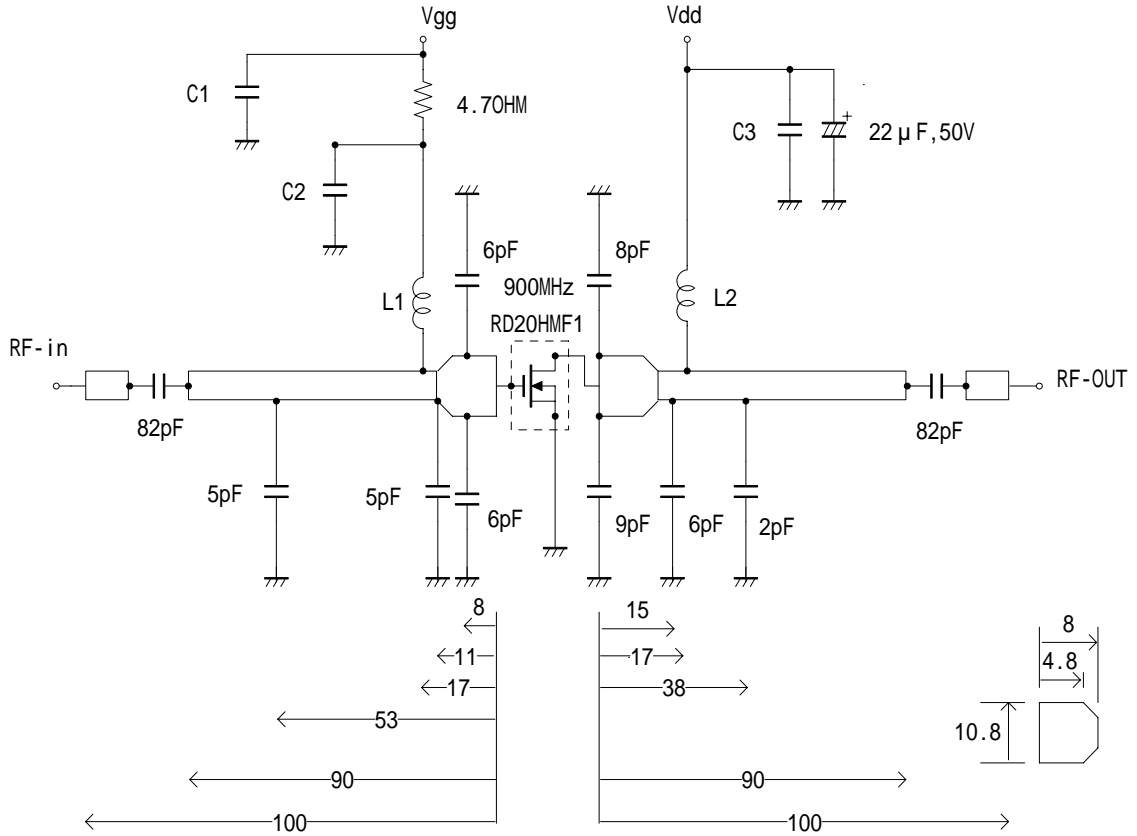

C1:1000pF,22000pF in parallel

C2:100pF*2 in parallel

C3:1000pF,22000pF in parallel

L1:1Turns, l.D3mm, D1.5mm silver plated copper wire

L2:1Turns, l.D3mm, D1.5mm silver plated copper wire

Note:Board material-Teflon substrate

micro strip line width=4.2mm/500HM,er:2.7,t=1.6mm

Dimensions:mm



ELECTROSTATIC SENSITIVE DEVICE
OBSERVE HANDLING PRECAUTIONS

MITSUBISHI RF POWER MOS FET

RD20HMF1

RoHS Compliance, Silicon MOSFET Power Transistor, 900MHz, 20W

INPUT/OUTPUT IMPEDANCE VS. FREQUENCY CHARACTERISTICS

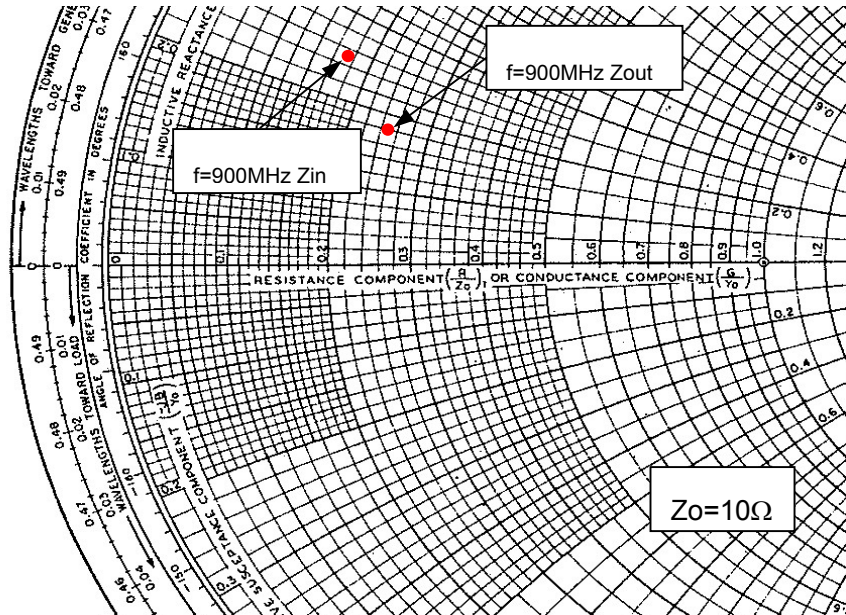

Zin , Zout

f (MHz)	Zin (ohm)	Zout (ohm)	Conditions
900	1.78+j2.50	2.52+j1.76	

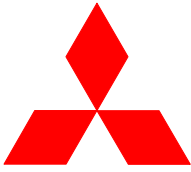

ELECTROSTATIC SENSITIVE DEVICE
OBSERVE HANDLING PRECAUTIONS

MITSUBISHI RF POWER MOS FET

RD20HMF1

RoHS Compliance, Silicon MOSFET Power Transistor, 900MHz, 20W

RD20HMF1 S-PARAMETER DATA (@Vdd=12.5V, Id=800mA)

Freq [MHz]	S11		S21		S12		S22	
	(mag)	(ang)	(mag)	(ang)	(mag)	(ang)	(mag)	(ang)
100	0.862	-168.4	8.814	83.5	0.016	-4.3	0.798	-172.5
200	0.868	-173.3	4.213	70.7	0.014	-10.9	0.813	-173.9
300	0.872	-174.8	2.614	60.4	0.012	-11.0	0.834	-174.6
400	0.882	-174.8	1.820	52.2	0.011	-16.2	0.856	-174.8
500	0.897	-176.1	1.343	44.6	0.009	-12.5	0.876	-175.6
600	0.912	-176.8	1.028	38.7	0.007	-5.3	0.887	-175.6
700	0.917	-177.8	0.812	33.5	0.006	7.6	0.907	-176.6
800	0.926	-178.6	0.663	29.4	0.005	25.8	0.920	-177.9
900	0.934	-179.3	0.560	25.9	0.006	43.8	0.930	-178.6
1000	0.947	179.5	0.482	23.0	0.007	54.0	0.941	-179.0
1100	0.953	178.6	0.421	19.7	0.008	62.2	0.947	-179.9
1200	0.959	177.2	0.358	16.8	0.009	68.5	0.950	179.3
1300	0.962	176.4	0.320	14.3	0.011	70.8	0.949	178.5
1400	0.966	174.8	0.292	12.3	0.013	75.6	0.951	177.8
1500	0.965	173.6	0.269	10.2	0.015	74.7	0.954	176.7
1600	0.963	172.0	0.244	8.1	0.016	75.4	0.944	175.4
1700	0.958	170.4	0.222	6.2	0.018	76.9	0.946	174.7
1800	0.956	168.8	0.202	3.8	0.020	74.8	0.949	173.2
1900	0.955	166.9	0.186	1.9	0.022	74.8	0.945	171.8
2000	0.953	165.2	0.177	0.3	0.024	73.3	0.947	170.1
2100	0.954	163.2	0.168	-2.0	0.026	74.1	0.945	168.6
2200	0.954	160.9	0.160	-3.6	0.028	71.7	0.945	166.9
2300	0.956	159.0	0.151	-6.2	0.030	70.0	0.943	164.7
2400	0.951	156.6	0.139	-8.1	0.032	67.4	0.935	162.6
2500	0.954	154.8	0.129	-10.0	0.034	65.4	0.935	160.4
2600	0.946	152.6	0.124	-12.1	0.037	63.6	0.936	158.0
2700	0.949	150.4	0.114	-13.3	0.039	60.1	0.934	155.2
2800	0.942	148.1	0.105	-13.0	0.040	56.5	0.933	152.4
2900	0.946	146.1	0.099	-12.1	0.041	54.0	0.932	149.9
3000	0.938	144.1	0.094	-10.3	0.044	51.0	0.931	147.2

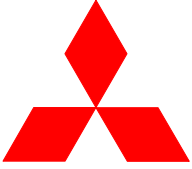

ELECTROSTATIC SENSITIVE DEVICE
OBSERVE HANDLING PRECAUTIONS

MITSUBISHI RF POWER MOS FET

RD20HMF1

RoHS Compliance, Silicon MOSFET Power Transistor, 900MHz, 20W

— Keep safety first in your circuit designs! —

Mitsubishi Electric Corporation puts the maximum effort into making semiconductor products better and more reliable, but there is always the possibility that trouble may occur with them. Trouble with semiconductors may lead to personal injury, fire or property damage. Remember to give due consideration to safety when making your circuit designs, with appropriate measures such as (i) placement of substitutive, auxiliary circuits, (ii) use of non-flammable material or (iii) prevention against any malfunction or mishap.