

MC14014B, MC14021B

8-Bit Static Shift Register

The MC14014B and MC14021B 8-bit static shift registers are constructed with MOS P-channel and N-channel enhancement mode devices in a single monolithic structure. These shift registers find primary use in parallel-to-serial data conversion, synchronous and asynchronous parallel input, serial output data queuing; and other general purpose register applications requiring low power and/or high noise immunity.

Features

- Synchronous Parallel Input/Serial Output (MC14014B)
- Asynchronous Parallel Input/Serial Output (MC14021B)
- Synchronous Serial Input/Serial Output
- Full Static Operation
- “Q” Outputs from Sixth, Seventh, and Eighth Stages
- Double Diode Input Protection
- Supply Voltage Range = 3.0 Vdc to 18 Vdc
- Capable of Driving Two Low-power TTL Loads or One Low-power Schottky TTL Load Over the Rated Temperature Range
- MC14014B Pin-for-Pin Replacement for CD4014B
- MC14021B Pin-for-Pin Replacement for CD4021B
- Pb-Free Packages are Available*

MAXIMUM RATINGS (Voltages Referenced to V_{SS})

Symbol	Parameter	Value	Unit
V_{DD}	DC Supply Voltage Range	-0.5 to +18.0	V
V_{in}, V_{out}	Input or Output Voltage Range (DC or Transient)	-0.5 to $V_{DD} + 0.5$	V
I_{in}, I_{out}	Input or Output Current (DC or Transient) per Pin	± 10	mA
P_D	Power Dissipation, per Package (Note 1)	500	mW
T_A	Ambient Temperature Range	-55 to +125	°C
T_{stg}	Storage Temperature Range	-65 to +150	°C
T_L	Lead Temperature (8-Second Soldering)	260	°C

Maximum ratings are those values beyond which device damage can occur. Maximum ratings applied to the device are individual stress limit values (not normal operating conditions) and are not valid simultaneously. If these limits are exceeded, device functional operation is not implied, damage may occur and reliability may be affected.

1. Temperature Derating:

Plastic “P and D/DW” Packages: - 7.0 mW/°C From 65°C To 125°C

This device contains protection circuitry to guard against damage due to high static voltages or electric fields. However, precautions must be taken to avoid applications of any voltage higher than maximum rated voltages to this high-impedance circuit. For proper operation, V_{in} and V_{out} should be constrained to the range $V_{SS} \leq (V_{in} \text{ or } V_{out}) \leq V_{DD}$.

Unused inputs must always be tied to an appropriate logic voltage level (e.g., either V_{SS} or V_{DD}). Unused outputs must be left open.

*For additional information on our Pb-Free strategy and soldering details, please download the ON Semiconductor Soldering and Mounting Techniques Reference Manual, SOLDERRM/D.



ON Semiconductor®

<http://onsemi.com>

MARKING DIAGRAMS

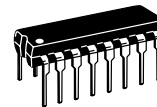

PDIP-16
P SUFFIX
CASE 648

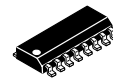

SOIC-16
D SUFFIX
CASE 751B

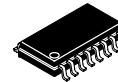
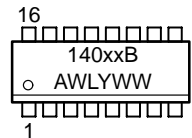

SOEIAJ-16
F SUFFIX
CASE 966

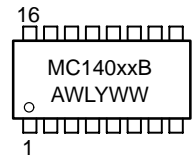

xx = Specific Device Code
A = Assembly Location
WL, L = Wafer Lot
YY, Y = Year
WW, W = Work Week

ORDERING INFORMATION

See detailed ordering and shipping information in the package dimensions section on page 6 of this data sheet.

MC14014B, MC14021B

TRUTH TABLE

SERIAL OPERATION:

t	Clock	D _S	P/S	Q6 t=n+6	Q7 t=n+7	Q8 t=n+8
n	↗	0	0	0	?	?
n+1	↗	1	0	1	0	?
n+2	↗	0	0	0	1	0
n+3	↗	1	0	1	0	1
	↘	X	0	Q6	Q7	Q8

PARALLEL OPERATION:

Clock		D _S	P/S	P _n	*Q _n
MC14014B	MC14021B				
↗	X	X	1	0	0
↗	X	X	1	1	1

*Q6, Q7, & Q8 are available externally
X = Don't Care

PIN ASSIGNMENT

P8	1 ●	16	V _{DD}
Q6	2	15	P7
Q8	3	14	P6
P4	4	13	P5
P3	5	12	Q7
P2	6	11	D _S
P1	7	10	C
V _{SS}	8	9	P/S

LOGIC DIAGRAM

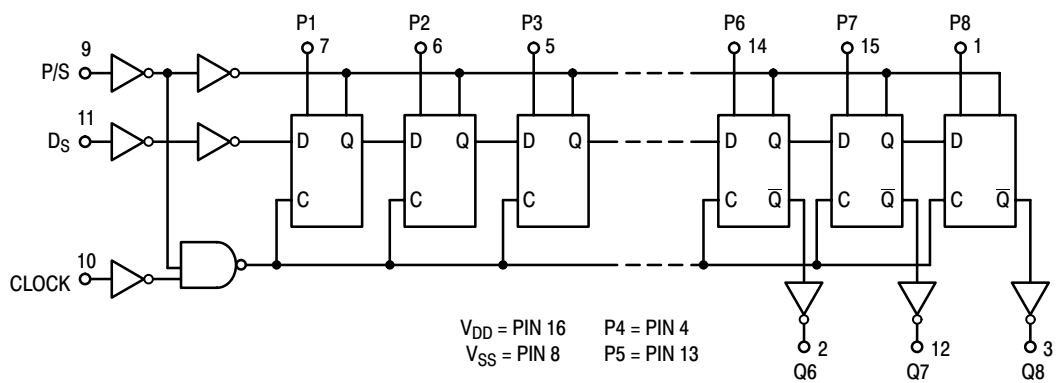

MC14014B, MC14021B

ELECTRICAL CHARACTERISTICS (Voltages Referenced to V_{SS})

Characteristic	Symbol	V_{DD} Vdc	- 55°C		25°C			125°C		Unit
			Min	Max	Min	Typ (Note 2)	Max	Min	Max	
Output Voltage $V_{in} = V_{DD}$ or 0 $V_{in} = 0$ or V_{DD}	"0" Level V_{OL}	5.0	-	0.05	-	0	0.05	-	0.05	Vdc
		10	-	0.05	-	0	0.05	-	0.05	
		15	-	0.05	-	0	0.05	-	0.05	
	"1" Level V_{OH}	5.0	4.95	-	4.95	5.0	-	4.95	-	Vdc
		10	9.95	-	9.95	10	-	9.95	-	
		15	14.95	-	14.95	15	-	14.95	-	
Input Voltage "0" Level ($V_O = 4.5$ or 0.5 Vdc) ($V_O = 9.0$ or 1.0 Vdc) ($V_O = 13.5$ or 1.5 Vdc) "1" Level ($V_O = 0.5$ or 4.5 Vdc) ($V_O = 1.0$ or 9.0 Vdc) ($V_O = 1.5$ or 13.5 Vdc)	V_{IL}	5.0	-	1.5	-	2.25	1.5	-	1.5	Vdc
		10	-	3.0	-	4.50	3.0	-	3.0	
		15	-	4.0	-	6.75	4.0	-	4.0	
	V_{IH}	5.0	3.5	-	3.5	2.75	-	3.5	-	Vdc
		10	7.0	-	7.0	5.50	-	7.0	-	
		15	11	-	11	8.25	-	11	-	
Output Drive Current ($V_{OH} = 2.5$ Vdc) ($V_{OH} = 4.6$ Vdc) ($V_{OH} = 9.5$ Vdc) ($V_{OH} = 13.5$ Vdc) ($V_{OL} = 0.4$ Vdc) ($V_{OL} = 0.5$ Vdc) ($V_{OL} = 1.5$ Vdc)	Source I_{OH}	5.0	-3.0	-	-2.4	-4.2	-	-1.7	-	mAdc
		5.0	-0.64	-	-0.51	-0.88	-	-0.36	-	
		10	-1.6	-	-1.3	-2.25	-	-0.9	-	
		15	-4.2	-	-3.4	-8.8	-	-2.4	-	
	Sink I_{OL}	5.0	0.64	-	0.51	0.88	-	0.36	-	mAdc
		10	1.6	-	1.3	2.25	-	0.9	-	
15		4.2	-	3.4	8.8	-	2.4	-		
Input Current	I_{in}	15	-	± 0.1	-	± 0.00001	± 0.1	-	± 1.0	μ Adc
Input Capacitance ($V_{in} = 0$)	C_{in}	-	-	-	-	5.0	7.5	-	-	pF
Quiescent Current (Per Package)	I_{DD}	5.0	-	5.0	-	0.005	5.0	-	150	μ Adc
		10	-	10	-	0.010	10	-	300	
		15	-	15	-	0.015	15	-	600	
Total Supply Current (Notes 3 & 4) (Dynamic plus Quiescent, Per Package) ($C_L = 50$ pF on all outputs, all buffers switching)	I_T	5.0 10 15	$I_T = (0.75 \mu\text{A/kHz}) f + I_{DD}$ $I_T = (1.50 \mu\text{A/kHz}) f + I_{DD}$ $I_T = (2.25 \mu\text{A/kHz}) f + I_{DD}$							μ Adc

2. Data labelled "Typ" is not to be used for design purposes but is intended as an indication of the IC's potential performance.

3. The formulas given are for the typical characteristics only at 25°C.

4. To calculate total supply current at loads other than 50 pF:

$$I_T(C_L) = I_T(50 \text{ pF}) + (C_L - 50) Vfk$$

where: I_T is in μA (per package), C_L in pF, $V = (V_{DD} - V_{SS})$ in volts, f in kHz is input frequency, and $k = 0.0015$.

MC14014B, MC14021B

SWITCHING CHARACTERISTICS (Note 5) ($C_L = 50 \text{ pF}$, $T_A = 25^\circ\text{C}$)

Characteristic	Symbol	V _{DD} Vdc	Min	Typ (Note 6)	Max	Unit
Output Rise and Fall Time $t_{TLH}, t_{THL} = (1.5 \text{ ns/pF}) C_L + 25 \text{ ns}$ $t_{TLH}, t_{THL} = (0.75 \text{ ns/pF}) C_L + 12.5 \text{ ns}$ $t_{TLH}, t_{THL} = (0.55 \text{ ns/pF}) C_L + 9.5 \text{ ns}$	$t_{TLH},$ t_{THL}	5.0 10 15	– – –	100 50 40	200 100 80	ns
Propagation Delay Time (Clock to Q, P/S to Q) $t_{PHL}, t_{PLH} = (1.7 \text{ ns/pF}) C_L + 315 \text{ ns}$ $t_{PHL}, t_{PLH} = (0.66 \text{ ns/pF}) C_L + 137 \text{ ns}$ $t_{PHL}, t_{PLH} = (0.5 \text{ ns/pF}) C_L + 90 \text{ ns}$	$t_{PLH},$ t_{PHL}	5.0 10 15	– – –	400 170 115	800 340 230	ns
Clock Pulse Width	t_{WH}	5.0 10 15	400 175 135	150 75 40	– – –	ns
Clock Frequency	f_{cl}	5.0 10 15	– – –	3.0 6.0 8.0	1.5 3.0 4.0	MHz
Parallel/Serial Control Pulse Width	t_{WH}	5.0 10 15	400 175 135	150 75 40	– – –	ns
Setup Time P/S to Clock	t_{su}	5.0 10 15	200 100 80	100 50 40	– – –	ns
Hold Time Clock to P/S	t_h	5.0 10 15	20 20 25	–2.5 –10 0	– – –	ns
Setup Time Data (Parallel or Serial) to Clock or P/S	t_{su}	5.0 10 15	350 80 60	150 50 30	– – –	ns
Hold Time Clock to D _s	t_h	5.0 10 15	45 35 35	0 0 5	– – –	ns
Hold Time Clock to P _n	t_h	5.0 10 15	50 45 45	25 20 20	– – –	ns
Input Clock Rise Time	$t_{r(cl)}$	5.0 10 15	– – –	– – –	15 5 4	μs

5. The formulas given are for the typical characteristics only at 25°C.

6. Data labelled "Typ" is not to be used for design purposes but is intended as an indication of the IC's potential performance.

MC14014B, MC14021B

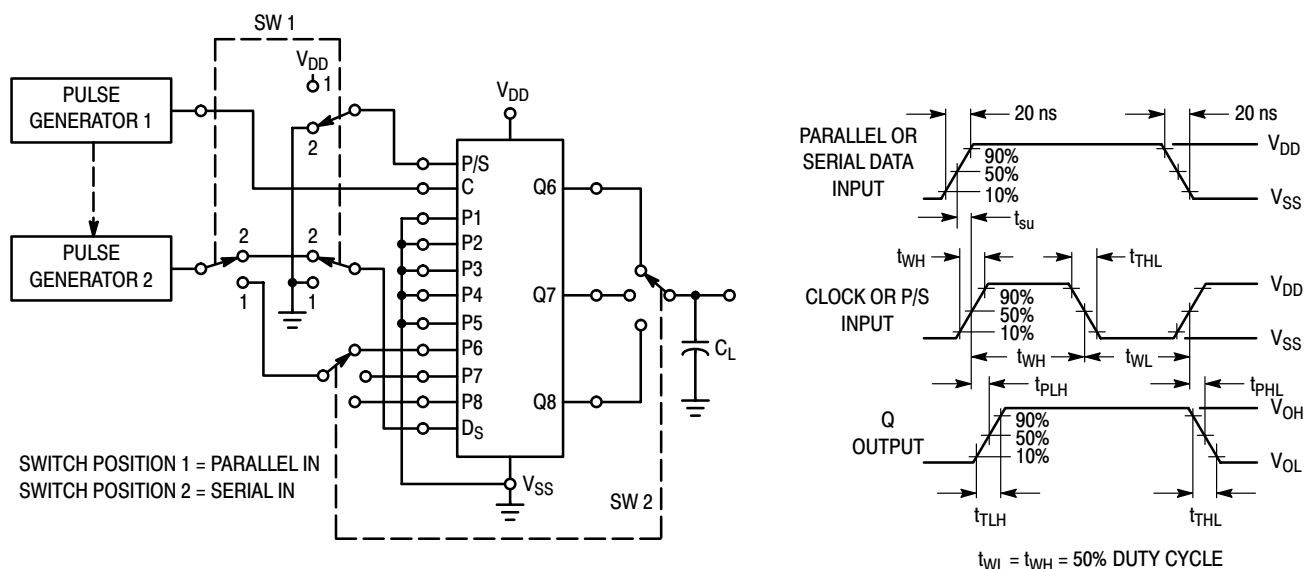

Figure 4. Switching Time Test Circuit and Waveforms

ORDERING INFORMATION

Device	Package	Shipping†
MC14014BCP	PDIP-16	500 Units / Rail
MC14014BCPG	PDIP-16 (Pb-Free)	500 Units / Rail
MC14014BD	SOIC-16	48 Units / Rail
MC14014BDG	SOIC-16 (Pb-Free)	48 Units / Rail
MC14014BDR2	SOIC-16	2500 Units / Tape & Reel
MC14014BDR2G	SOIC-16 (Pb-Free)	2500 Units / Tape & Reel
MC14014BF	SOEIAJ-16	50 Units / Rail
MC14014BFEL	SOEIAJ-16	2000 Units / Tape & Reel
MC14021BCP	PDIP-16	500 Units / Rail
MC14021BCPG	PDIP-16 (Pb-Free)	500 Units / Rail
MC14021BD	SOIC-16	48 Units / Rail
MC14021BDG	SOIC-16 (Pb-Free)	48 Units / Rail
MC14021BDR2	SOIC-16	2500 Units / Tape & Reel
MC14021BDR2G	SOIC-16 (Pb-Free)	2500 Units / Tape & Reel
MC14021BF	SOEIAJ-16	50 Units / Rail
MC14021BFEL	SOEIAJ-16	2000 Units / Tape & Reel

†For information on tape and reel specifications, including part orientation and tape sizes, please refer to our Tape and Reel Packaging Specifications Brochure, BRD8011/D.

MC14014B, MC14021B

PACKAGE DIMENSIONS

PDIP-16
P SUFFIX
PLASTIC DIP PACKAGE
CASE 648-08
ISSUE T

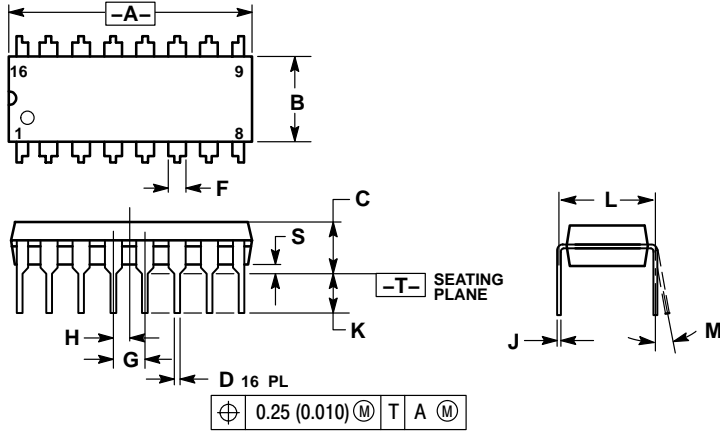

NOTES:

1. DIMENSIONING AND TOLERANCING PER ANSI Y14.5M, 1982.
2. CONTROLLING DIMENSION: INCH.
3. DIMENSION L TO CENTER OF LEADS WHEN FORMED PARALLEL.
4. DIMENSION B DOES NOT INCLUDE MOLD FLASH.
5. ROUNDED CORNERS OPTIONAL.

DIM	INCHES		MILLIMETERS	
	MIN	MAX	MIN	MAX
A	0.740	0.770	18.80	19.55
B	0.250	0.270	6.35	6.85
C	0.145	0.175	3.69	4.44
D	0.015	0.021	0.39	0.53
F	0.040	0.70	1.02	1.77
G	0.100 BSC		2.54 BSC	
H	0.050 BSC		1.27 BSC	
J	0.008	0.015	0.21	0.38
K	0.110	0.130	2.80	3.30
L	0.295	0.305	7.50	7.74
M	0°	10°	0°	10°
S	0.020	0.040	0.51	1.01

SOIC-16
D SUFFIX
PLASTIC SOIC PACKAGE
CASE 751B-05
ISSUE J

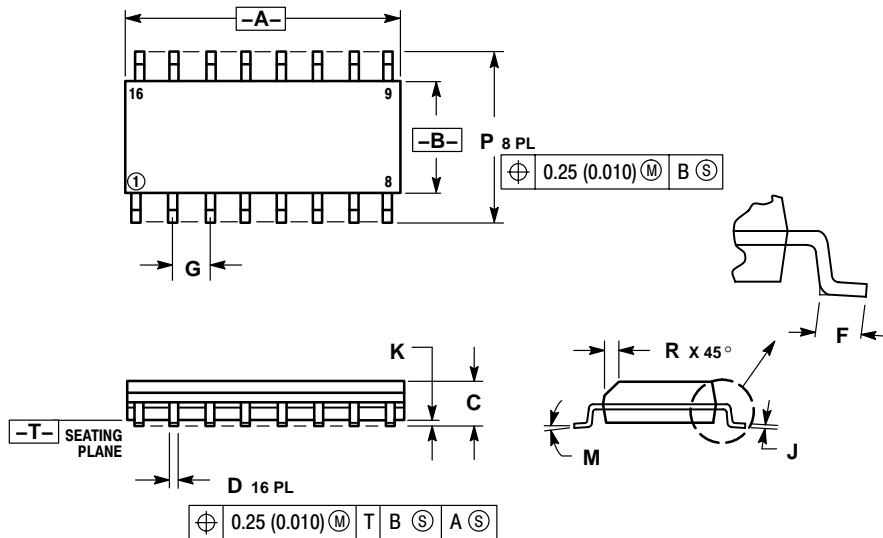

NOTES:

1. DIMENSIONING AND TOLERANCING PER ANSI Y14.5M, 1982.
2. CONTROLLING DIMENSION: MILLIMETER.
3. DIMENSIONS A AND B DO NOT INCLUDE MOLD PROTRUSION.
4. MAXIMUM MOLD PROTRUSION 0.15 (0.006) PER SIDE.
5. DIMENSION D DOES NOT INCLUDE DAMBAR PROTRUSION. ALLOWABLE DAMBAR PROTRUSION SHALL BE 0.127 (0.005) TOTAL IN EXCESS OF THE D DIMENSION AT MAXIMUM MATERIAL CONDITION.

DIM	MILLIMETERS		INCHES	
	MIN	MAX	MIN	MAX
A	9.80	10.00	0.386	0.393
B	3.80	4.00	0.150	0.157
C	1.35	1.75	0.054	0.068
D	0.35	0.49	0.014	0.019
F	0.40	1.25	0.016	0.049
G	1.27 BSC		0.050 BSC	
J	0.19	0.25	0.008	0.009
K	0.10	0.25	0.004	0.009
M	0°	7°	0°	7°
P	5.80	6.20	0.229	0.244
R	0.25	0.50	0.010	0.019

MC14014B, MC14021B

PACKAGE DIMENSIONS

SOEIAJ-16 F SUFFIX PLASTIC EIAJ SOIC PACKAGE CASE 966-01 ISSUE O

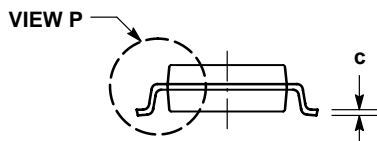
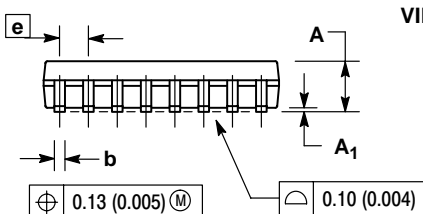
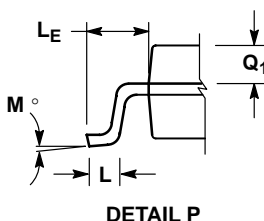
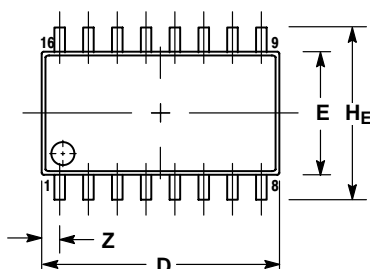

NOTES:

1. DIMENSIONING AND TOLERANCING PER ANSI Y14.5M, 1982.
2. CONTROLLING DIMENSION: MILLIMETER.
3. DIMENSIONS D AND E DO NOT INCLUDE MOLD FLASH OR PROTRUSIONS AND ARE MEASURED AT THE PARTING LINE. MOLD FLASH OR PROTRUSIONS SHALL NOT EXCEED 0.15 (0.006) PER SIDE.
4. TERMINAL NUMBERS ARE SHOWN FOR REFERENCE ONLY.
5. THE LEAD WIDTH DIMENSION (b) DOES NOT INCLUDE DAMBAR PROTRUSION. ALLOWABLE DAMBAR PROTRUSION SHALL BE 0.08 (0.003) TOTAL IN EXCESS OF THE LEAD WIDTH DIMENSION AT MAXIMUM MATERIAL CONDITION. DAMBAR CANNOT BE LOCATED ON THE LOWER RADIUS OR THE FOOT. MINIMUM SPACE BETWEEN PROTRUSIONS AND ADJACENT LEAD TO BE 0.46 (0.018).

DIM	MILLIMETERS		INCHES	
	MIN	MAX	MIN	MAX
A	---	2.05	---	0.081
A ₁	0.05	0.20	0.002	0.008
b	0.35	0.50	0.014	0.020
c	0.18	0.27	0.007	0.011
D	9.90	10.50	0.390	0.413
E	5.10	5.45	0.201	0.215
e	1.27 BSC		0.050 BSC	
HE	7.40	8.20	0.291	0.323
L	0.50	0.85	0.020	0.033
LE	1.10	1.50	0.043	0.059
M	0°	10°	0°	10°
Q ₁	0.70	0.90	0.028	0.035
Z	---	0.78	---	0.031

ON Semiconductor and  are registered trademarks of Semiconductor Components Industries, LLC (SCILLC). SCILLC reserves the right to make changes without further notice to any products herein. SCILLC makes no warranty, representation or guarantee regarding the suitability of its products for any particular purpose, nor does SCILLC assume any liability arising out of the application or use of any product or circuit, and specifically disclaims any and all liability, including without limitation special, consequential or incidental damages. "Typical" parameters which may be provided in SCILLC data sheets and/or specifications can and do vary in different applications and actual performance may vary over time. All operating parameters, including "Typicals" must be validated for each customer application by customer's technical experts. SCILLC does not convey any license under its patent rights nor the rights of others. SCILLC products are not designed, intended, or authorized for use as components in systems intended for surgical implant into the body, or other applications intended to support or sustain life, or for any other application in which the failure of the SCILLC product could create a situation where personal injury or death may occur. Should Buyer purchase or use SCILLC products for any such unintended or unauthorized application, Buyer shall indemnify and hold SCILLC and its officers, employees, subsidiaries, affiliates, and distributors harmless against all claims, costs, damages, and expenses, and reasonable attorney fees arising out of, directly or indirectly, any claim of personal injury or death associated with such unintended or unauthorized use, even if such claim alleges that SCILLC was negligent regarding the design or manufacture of the part. SCILLC is an Equal Opportunity/Affirmative Action Employer. This literature is subject to all applicable copyright laws and is not for resale in any manner.

PUBLICATION ORDERING INFORMATION

LITERATURE FULFILLMENT:

Literature Distribution Center for ON Semiconductor
P.O. Box 61312, Phoenix, Arizona 85082-1312 USA
Phone: 480-829-7710 or 800-344-3860 Toll Free USA/Canada
Fax: 480-829-7709 or 800-344-3867 Toll Free USA/Canada
Email: orderlit@onsemi.com

N. American Technical Support: 800-282-9855 Toll Free
USA/Canada

Japan: ON Semiconductor, Japan Customer Focus Center
2-9-1 Kamimeguro, Meguro-ku, Tokyo, Japan 153-0051
Phone: 81-3-5773-3850

ON Semiconductor Website: <http://onsemi.com>

Order Literature: <http://www.onsemi.com/litorder>

For additional information, please contact your local Sales Representative.