



# 8-/10-/12-Bit High Bandwidth Multiplying DACs with Serial Interface

## AD5426/AD5432/AD5443\*

### FEATURES

- 3.0 V to 5.5 V Supply Operation
- 50 MHz Serial Interface
- 10 MHz Multiplying Bandwidth
- $\pm 10$  V Reference Input
- Low Glitch Energy  $< 2$  nV-s
- Extended Temperature Range  $-40^{\circ}\text{C}$  to  $+125^{\circ}\text{C}$
- 10-Lead MSOP Package
- Pin Compatible 8-, 10-, and 12-Bit Current Output DACs
- Guaranteed Monotonic
- 4-Quadrant Multiplication
- Power-On Reset with Brownout Detection
- Daisy-chain Mode
- Readback Function
- 0.4  $\mu\text{A}$  Typical Power Consumption

### APPLICATIONS

- Portable Battery-Powered Applications
- Waveform Generators
- Analog Processing
- Instrumentation Applications
- Programmable Amplifiers and Attenuators
- Digitally Controlled Calibration
- Programmable Filters and Oscillators
- Composite Video
- Ultrasound
- Gain, Offset, and Voltage Trimming

### GENERAL DESCRIPTION

The AD5426/AD5432/AD5443 are CMOS 8-, 10-, and 12-bit current output digital-to-analog converters, respectively.

These devices operate from a 3.0 V to 5.5 V power supply, making them suited to battery-powered applications and many other applications.

These DACs utilize double buffered 3-wire serial interface that is compatible with SPI<sup>®</sup>, QSPI<sup>™</sup>, MICROWIRE<sup>™</sup>, and most DSP interface standards. In addition, a serial data out pin (SDO) allows for daisy-chaining when multiple packages are used. Data readback allows the user to read the contents of the DAC register via the SDO pin. On power-up, the internal shift register and latches are filled with 0s and the DAC outputs are at zero scale.

As a result of manufacture on a CMOS submicron process, they offer excellent 4-quadrant multiplication characteristics, with large signal multiplying bandwidths of 10 MHz.

\*U.S. Patent No. 5,689,257

REV. 0

Information furnished by Analog Devices is believed to be accurate and reliable. However, no responsibility is assumed by Analog Devices for its use, nor for any infringements of patents or other rights of third parties that may result from its use. No license is granted by implication or otherwise under any patent or patent rights of Analog Devices. Trademarks and registered trademarks are the property of their respective owners.

### FUNCTIONAL BLOCK DIAGRAM

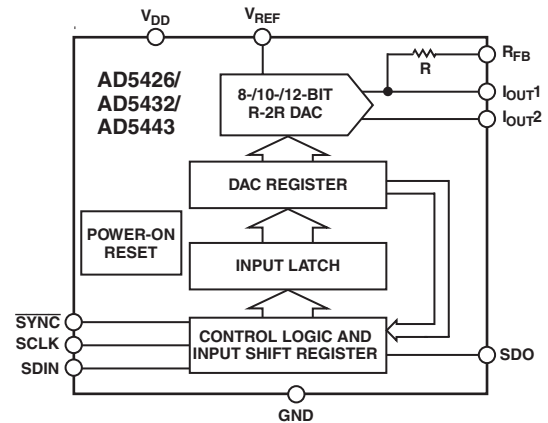

The applied external reference input voltage ( $V_{\text{REF}}$ ) determines the full-scale output current. An integrated feedback resistor ( $R_{\text{FB}}$ ) provides temperature tracking and full-scale voltage output when combined with an external current to voltage precision amplifier.

The AD5426/AD5432/AD5443 DACs are available in small 10-lead MSOP packages.

# AD5426/AD5432/AD5443—SPECIFICATIONS<sup>1</sup>

( $V_{DD} = 3\text{ V to }5.5\text{ V}$ ,  $V_{REF} = 10\text{ V}$ ,  $I_{OUTX} = 0\text{ V}$ . All specifications  $T_{MIN}$  to  $T_{MAX}$ , unless otherwise noted. DC performance measured with OP177, AC performance with AD8038, unless otherwise noted.)

Parameter	Min	Typ	Max	Unit	Conditions
<b>STATIC PERFORMANCE</b>					
AD5426					
Resolution			8	Bits	Guaranteed monotonic
Relative Accuracy			$\pm 0.25$	LSB	
Differential Nonlinearity			$\pm 0.5$	LSB	
AD5432					
Resolution			10	Bits	Guaranteed monotonic
Relative Accuracy			$\pm 0.5$	LSB	
Differential Nonlinearity			$\pm 1$	LSB	
AD5443					
Resolution			12	Bits	Guaranteed monotonic
Relative Accuracy			$\pm 1$	LSB	
Differential Nonlinearity			$-1/+2$	LSB	
Gain Error			$\pm 10$	mV	
Gain Error Temperature Coefficient <sup>2</sup>		$\pm 5$		ppm FSR/°C	
Output Leakage Current			$\pm 5$ $\pm 25$	nA nA	Data = 0x0000, $T_A = 25^\circ\text{C}$ , $I_{OUT}$ Data = 0x0000, $I_{OUT}$
<b>REFERENCE INPUT<sup>2</sup></b>					
Reference Input Range			$\pm 10$	V	
$V_{REF}$ Input Resistance	8	10	12	k $\Omega$	Input resistance TC = $-50\text{ ppm}/^\circ\text{C}$
$R_{FB}$ Resistance	8	10	12	k $\Omega$	Input resistance TC = $-50\text{ ppm}/^\circ\text{C}$
Input Capacitance					
Code All 0s		3	6	pF	
Code All 1s		5	8	pF	
<b>DIGITAL INPUTS/OUTPUT<sup>2</sup></b>					
Input High Voltage, $V_{IH}$	1.7			V	
Input Low Voltage, $V_{IL}$			0.6	V	
Input Leakage Current, $I_{IL}$			2	$\mu\text{A}$	
Input Capacitance		4	10	pF	
$V_{DD} = 4.5\text{ V to }5.5\text{ V}$					
Output Low Voltage, $V_{OL}$			0.4	V	$I_{SINK} = 200\ \mu\text{A}$
Output High Voltage, $V_{OH}$	$V_{DD} - 1$			V	$I_{SOURCE} = 200\ \mu\text{A}$
$V_{DD} = 3\text{ V to }3.6\text{ V}$					
Output Low Voltage, $V_{OL}$			0.4	V	$I_{SINK} = 200\ \mu\text{A}$
Output High Voltage, $V_{OH}$	$V_{DD} - 0.5$			V	$I_{SOURCE} = 200\ \mu\text{A}$
<b>DYNAMIC PERFORMANCE<sup>2</sup></b>					
Reference Multiplying Bandwidth		10		MHz	$V_{REF} = \pm 3.5\text{ V}$ ; DAC loaded all 1s
Output Voltage Settling Time					$V_{REF} = 10\text{ V}$ ; $R_{LOAD} = 100\ \Omega$ , $C_{LOAD} = 15\text{ pF}$
AD5426		50	100	ns	Measured to $\pm 16\text{ mV}$ of full scale
AD5432		55	110	ns	Measured to $\pm 4\text{ mV}$ of full scale
AD5443		90	160	ns	Measured to $\pm 1\text{ mV}$ of full scale
Digital Delay		40	75	ns	Interface Delay Time
10% to 90% Rise/Fall Time		15	30	ns	Rise and fall time, $V_{REF} = 10\text{ V}$ , $R_{LOAD} = 100\ \Omega$
Digital-to-Analog Glitch Impulse		2		nV-s	1 LSB change around major carry, $V_{REF} = 0\text{ V}$
Multiplying Feedthrough Error					DAC latch loaded with all 0s. $V_{REF} = \pm 3.5\text{ V}$
		70		dB	1 MHz
		48		dB	10 MHz
Output Capacitance					
$I_{OUT2}$		22	25	pF	All 0s loaded
		10	12	pF	All 1s loaded
$I_{OUT1}$		12	17	pF	All 0s loaded
		25	30	pF	All 1s loaded
Digital Feedthrough		0.1		nV-s	Feedthrough to DAC output with $\overline{\text{SYNC}}$ high and alternate loading of all 0s and all 1s
Total Harmonic Distortion		$-81$		dB	$V_{REF} = 3.5\text{ V pk-pk}$ ; all 1s loaded, $f = 1\text{ kHz}$
Digital THD Clock = 1 MHz					
50 kHz $f_{OUT}$		73		dB	
Output Noise Spectral Density		25		nV/ $\sqrt{\text{Hz}}$	@ 1 kHz

Parameter	Min	Typ	Max	Unit	Conditions
SFDR Performance (Wide Band) Clock = 10 MHz					AD5443, 4096 codes $V_{REF} = 3.5\text{ V}$
50 kHz $f_{OUT}$		75		dB	
20 kHz $f_{OUT}$		76		dB	
SFDR Performance (Narrow Band) Clock = 1 MHz					
50 kHz $f_{OUT}$		87		dB	
20 kHz $f_{OUT}$		87		dB	
Intermodulation Distortion Clock = 1 MHz $f_1 = 20\text{ kHz}$ , $f_2 = 25\text{ kHz}$		78		dB	
<b>POWER REQUIREMENTS</b>					
Power Supply Range	3.0		5.5	V	Logic inputs = 0 V or $V_{DD}$ $T_A = 25^\circ\text{C}$ , logic inputs = 0 V or $V_{DD}$
$I_{DD}$		0.4	5	$\mu\text{A}$	
			0.6	$\mu\text{A}$	

**NOTES**

<sup>1</sup>Temperature range is as follows: Y version:  $-40^\circ\text{C}$  to  $+125^\circ\text{C}$ .

<sup>2</sup>Guaranteed by design and characterization, not subject to production test.

Specifications subject to change without notice.

# AD5426/AD5432/AD5443

## TIMING CHARACTERISTICS<sup>1</sup> ( $V_{DD} = 3\text{ V to } 5.5\text{ V}$ , $V_{REF} = 10\text{ V}$ , $I_{OUT2} = 0\text{ V}$ . All specifications $T_{MIN}$ to $T_{MAX}$ , unless otherwise noted.)

Parameter	3.0 V to 5.5 V	4.5 V to 5.5 V	Unit	Conditions/Comments
$f_{SCLK}$	50	50	MHz max	Max clock frequency
$t_1$	20	20	ns min	SCLK cycle time
$t_2$	8	8	ns min	SCLK high time
$t_3$	8	8	ns min	SCLK low time
$t_4^2$	13	13	ns min	$\overline{SYNC}$ falling edge to SCLK active edge setup time
$t_5$	5	5	ns min	Data setup time
$t_6$	3	3	ns min	Data hold time
$t_7$	5	5	ns min	$\overline{SYNC}$ rising edge to SCLK active edge
$t_8$	30	30	ns min	Minimum $\overline{SYNC}$ high time
$t_9^3$	80	45	ns typ	SCLK active edge to SDO valid
	120	65	ns max	

### NOTES

<sup>1</sup>See Figures 1 and 2. Temperature range is as follows: Y version:  $-40^{\circ}\text{C}$  to  $+125^{\circ}\text{C}$ . Guaranteed by design and characterization, not subject to production test.

All input signals are specified with  $t_r = t_f = 1\text{ ns}$  (10% to 90% of  $V_{DD}$ ) and timed from a voltage level of  $(V_{IL} + V_{IH})/2$ .

<sup>2</sup>Falling or rising edge as determined by control bits of serial word.

<sup>3</sup>Daisy-chain and readback modes cannot operate at max clock frequency. SDO timing specifications measured with load circuit as shown in Figure 3.

Specifications subject to change without notice.

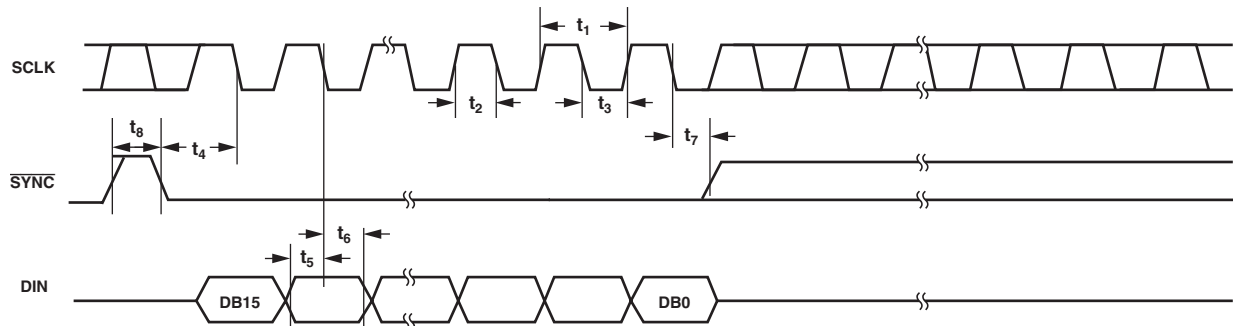

ALTERNATIVELY, DATA MAY BE CLOCKED INTO INPUT SHIFT REGISTER ON RISING EDGE OF SCLK AS DETERMINED BY CONTROL BITS. TIMING AS PER ABOVE, WITH SCLK INVERTED.

Figure 1. Standalone Mode Timing Diagram

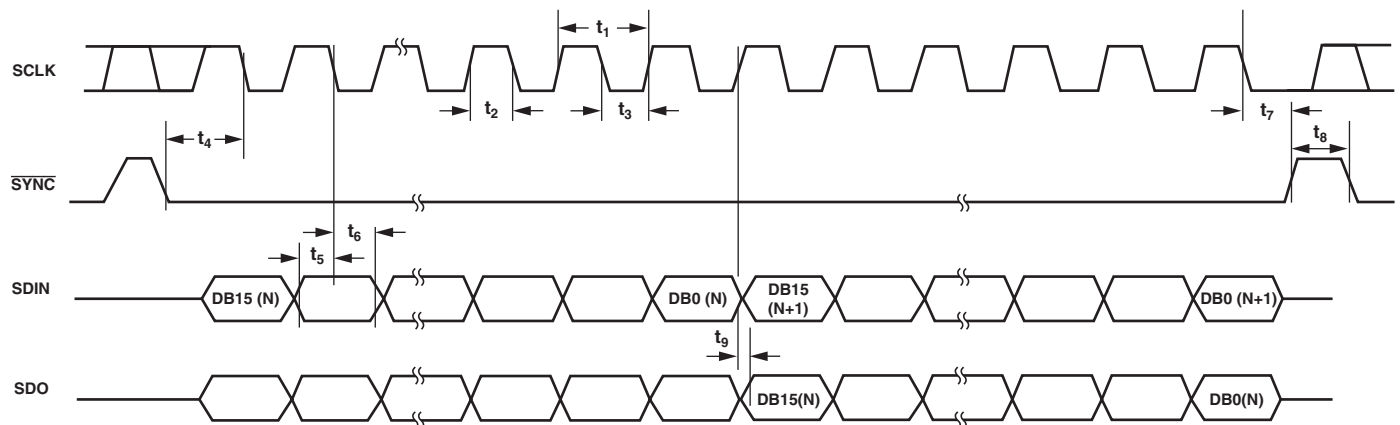

ALTERNATIVELY, DATA MAY BE CLOCKED INTO INPUT SHIFT REGISTER ON RISING EDGE OF SCLK AS DETERMINED BY CONTROL BITS. IN THIS CASE, DATA WOULD BE CLOCKED OUT OF SDO ON FALLING EDGE OF SCLK. TIMING AS PER ABOVE, WITH SCLK INVERTED.

Figure 2. Daisy-chain and Readback Modes Timing Diagram

## ABSOLUTE MAXIMUM RATINGS<sup>1, 2</sup>

(T<sub>A</sub> = 25°C, unless otherwise noted.)

V <sub>DD</sub> to GND	.....	-0.3 V to +7 V
V <sub>REF</sub> , R <sub>FB</sub> to GND	.....	-12 V to +12 V
I <sub>OUT1</sub> , I <sub>OUT2</sub> to GND	.....	-0.3 V to +7 V
Logic Inputs and Output <sup>3</sup>	.....	-0.3 V to V <sub>DD</sub> + 0.3 V
<b>Operating Temperature Range</b>		
Extended Industrial (Y Version)	.....	-40°C to +125°C
Storage Temperature Range	.....	-65°C to +150°C
Junction Temperature	.....	150°C
10-lead MSOP θ <sub>JA</sub> Thermal Impedance	.....	206°C/W
Lead Temperature, Soldering (10 seconds)	.....	300°C
IR Reflow, Peak Temperature (<20 seconds)	.....	235°C

### NOTES

<sup>1</sup> Stresses above those listed under Absolute Maximum Ratings may cause permanent damage to the device. This is a stress rating only and functional operation of the device at these or any other conditions above those listed in the operational sections of this specification is not implied. Exposure to absolute maximum rating conditions for extended periods may affect device reliability. Only one absolute maximum rating may be applied at any one time.

<sup>2</sup> Transient currents of up to 100 mA will not cause SCR latchup.

<sup>3</sup> Overvoltages at SCLK, SYNC, and DIN, will be clamped by internal diodes.

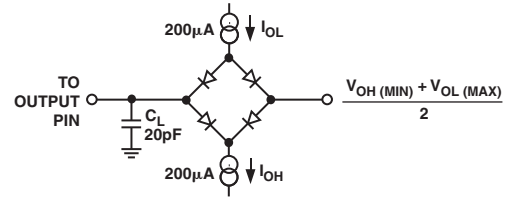

Figure 3. Load Circuit for SDO Timing Specifications

## ORDERING GUIDE

Model	Resolution (Bit)	INL (LSB)	Temperature Range	Package Description	Branding	Package Option
AD5426YRM	8	±0.25	-40°C to +125°C	MSOP	D1Q	RM-10
AD5426YRM-REEL	8	±0.25	-40°C to +125°C	MSOP	D1Q	RM-10
AD5426YRM-REEL7	8	±0.25	-40°C to +125°C	MSOP	D1Q	RM-10
AD5432YRM	10	±0.5	-40°C to +125°C	MSOP	D1R	RM-10
AD5432YRM-REEL	10	±0.5	-40°C to +125°C	MSOP	D1R	RM-10
AD5432YRM-REEL7	10	±0.5	-40°C to +125°C	MSOP	D1R	RM-10
AD5443YRM	12	±1	-40°C to +125°C	MSOP	D1S	RM-10
AD5443YRM-REEL	12	±1	-40°C to +125°C	MSOP	D1S	RM-10
AD5443YRM-REEL7	12	±1	-40°C to +125°C	MSOP	D1S	RM-10
EVAL-AD5426EB				Evaluation Kit		
EVAL-AD5432EB				Evaluation Kit		
EVAL-AD5443EB				Evaluation Kit		

### CAUTION

ESD (electrostatic discharge) sensitive device. Electrostatic charges as high as 4000 V readily accumulate on the human body and test equipment and can discharge without detection. Although the AD5426/AD5432/AD5443 features proprietary ESD protection circuitry, permanent damage may occur on devices subjected to high energy electrostatic discharges. Therefore, proper ESD precautions are recommended to avoid performance degradation or loss of functionality.



# AD5426/AD5432/AD5443

## PIN CONFIGURATION

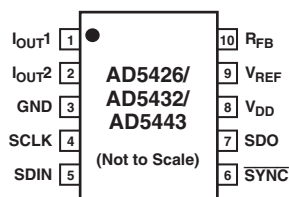

## PIN FUNCTION DESCRIPTIONS

Pin No.	Mnemonic	Function
1	I <sub>OUT1</sub>	DAC Current Output.
2	I <sub>OUT2</sub>	DAC Analog Ground. This pin should normally be tied to the analog ground of the system.
3	GND	Ground Pin.
4	SCLK	Serial Clock Input. By default, data is clocked into the input shift register on the falling edge of the serial clock input. Alternatively, by means of the serial control bits, the device may be configured such that data is clocked into the shift register on the rising edge of SCLK.
5	SDIN	Serial Data Input. Data is clocked into the 16-bit input register on the active edge of the serial clock input. By default, on power-up, data is clocked into the shift register on the falling edge of SCLK. The control bits allow the user to change the active edge to rising edge.
6	$\overline{\text{SYNC}}$	Active Low Control Input. This is the frame synchronization signal for the input data. When $\overline{\text{SYNC}}$ goes low, it powers on the SCLK and DIN buffers, and the input shift register is enabled. Data is loaded to the shift register on the active edge of the following clocks (power-on default is falling clock edge). In standalone mode, the serial interface counts clocks and data is latched to the shift register on the 16th active clock edge.
7	SDO	Serial Data Output. This allows a number of parts to be daisy-chained. By default, data is clocked into the shift register on the falling edge and out via SDO on the rising edge of SCLK. Data will always be clocked out on the alternate edge to loading data to the shift register. Writing the Readback control word to the shift register makes the DAC register contents available for readback on the SDO pin, clocked out on the opposite edges to the active clock edge.
8	V <sub>DD</sub>	Positive Power Supply Input. These parts can be operated from a supply of 3 V to 5.5 V.
9	V <sub>REF</sub>	DAC Reference Voltage Input.
10	R <sub>FB</sub>	DAC Feedback Resistor pin. Establish voltage output for the DAC by connecting to external amplifier output.

# Typical Performance Characteristics—AD5426/AD5432/AD5443

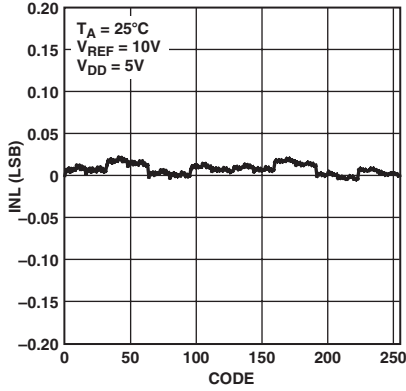

TPC 1. INL vs. Code (8-Bit DAC)

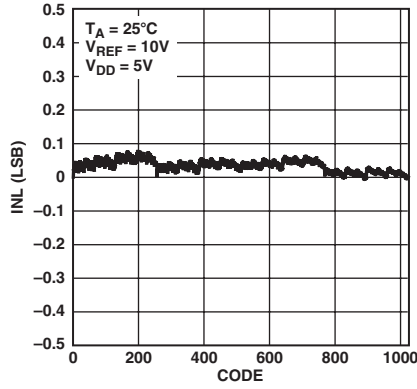

TPC 2. INL vs. Code (10-Bit DAC)

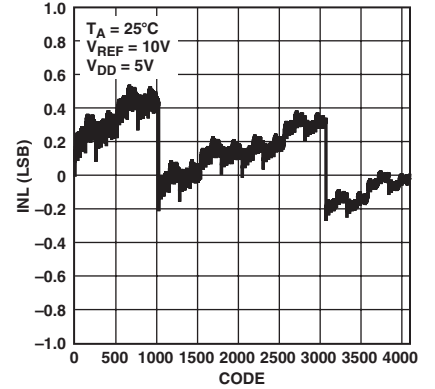

TPC 3. INL vs. Code (12-Bit DAC)

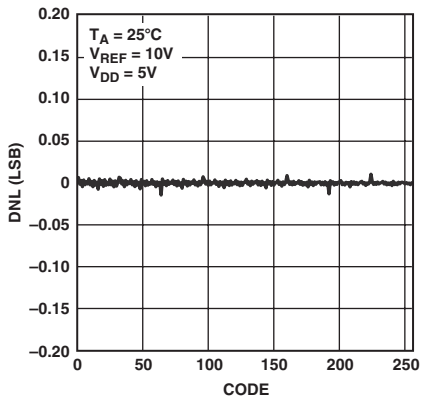

TPC 4. DNL vs. Code (8-Bit DAC)

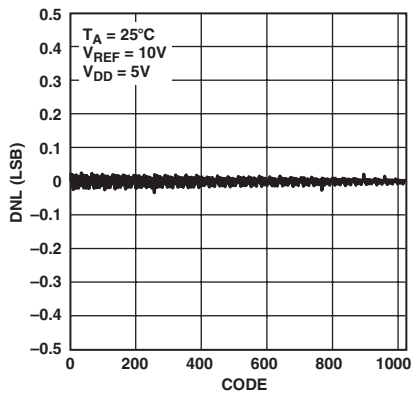

TPC 5. DNL vs. Code (10-Bit DAC)

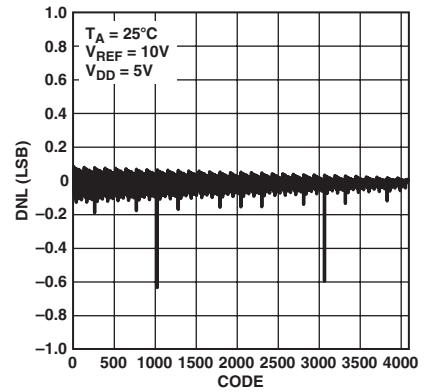

TPC 6. DNL vs. Code (12-Bit DAC)

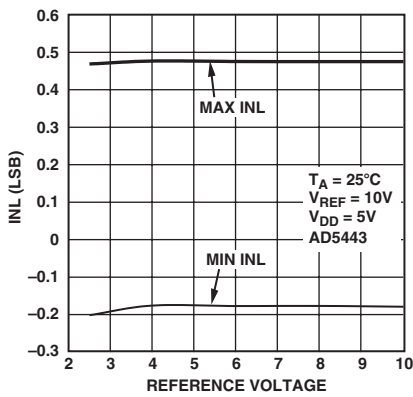

TPC 7. INL vs. Reference Voltage

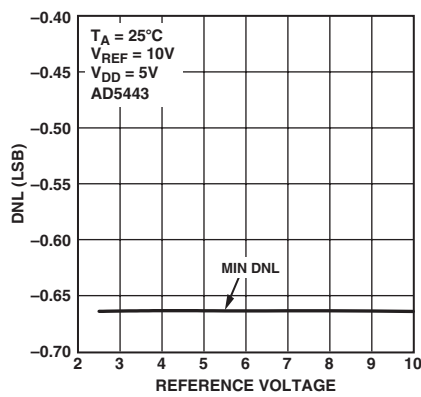

TPC 8. DNL vs. Reference Voltage

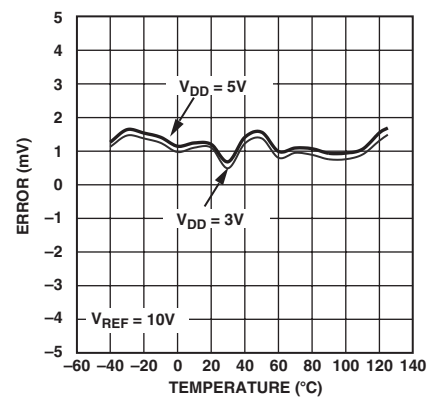

TPC 9. Gain Error vs. Temperature

# AD5426/AD5432/AD5443

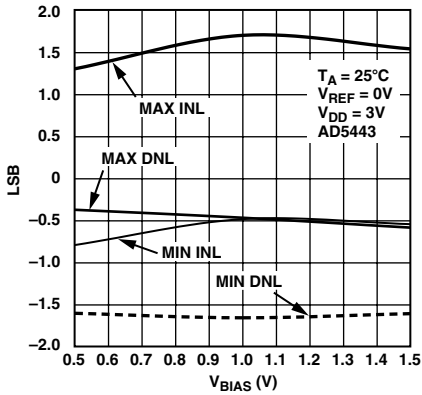

TPC 10. Linearity vs.  $V_{BIAS}$  Voltage Applied to  $I_{OUT2}$

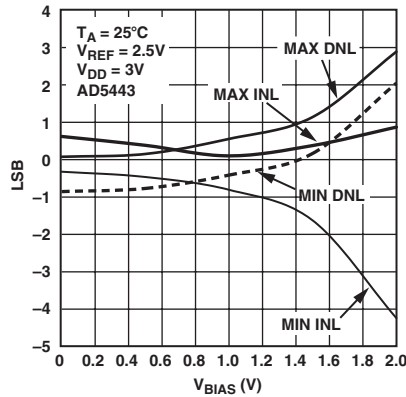

TPC 11. Linearity vs.  $V_{BIAS}$  Voltage Applied to  $I_{OUT2}$

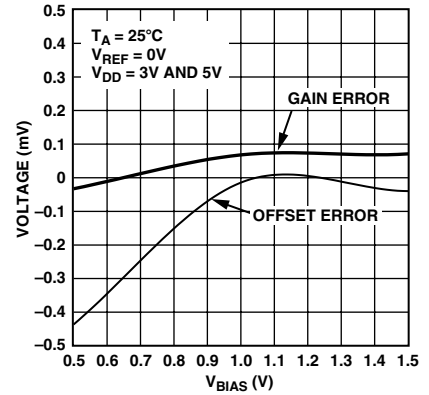

TPC 12. Gain and Offset Errors vs.  $V_{BIAS}$  Voltage Applied to  $I_{OUT2}$

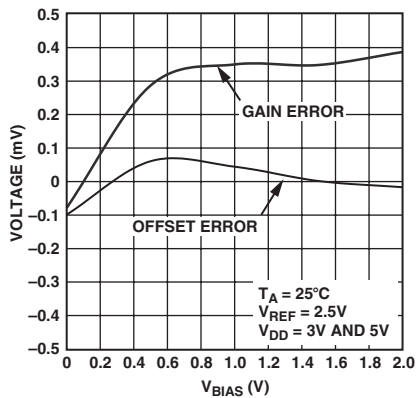

TPC 13. Gain and Offset Errors vs.  $V_{BIAS}$  Voltage Applied to  $I_{OUT2}$

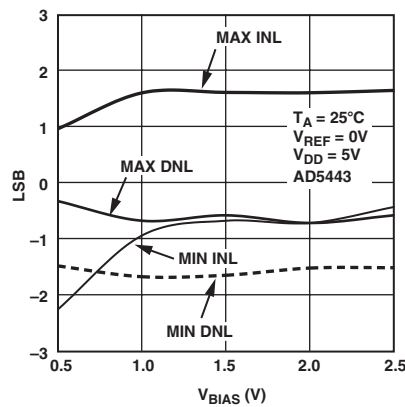

TPC 14. Linearity vs.  $V_{BIAS}$  Voltage Applied to  $I_{OUT2}$

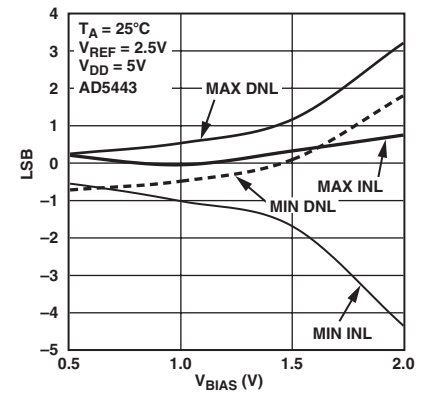

TPC 15. Linearity vs.  $V_{BIAS}$  Voltage Applied to  $I_{OUT2}$

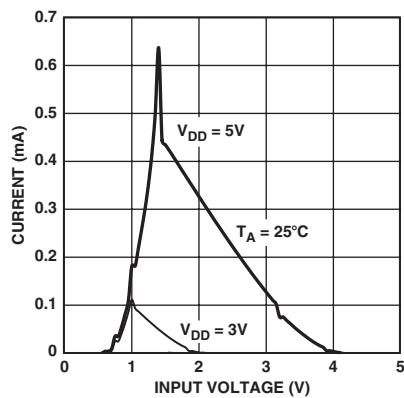

TPC 16. Supply Current vs. Logic Input Voltage,  $\overline{SYNC}$  ( $SCLK, DATA = 0$ )

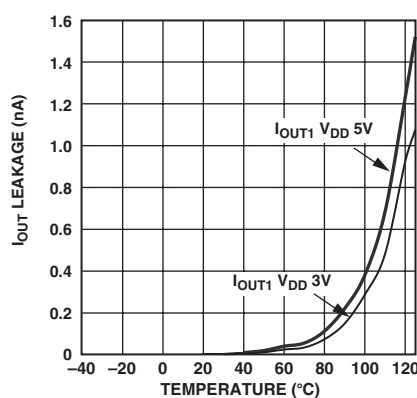

TPC 17.  $I_{OUT1}$  Leakage Current vs. Temperature

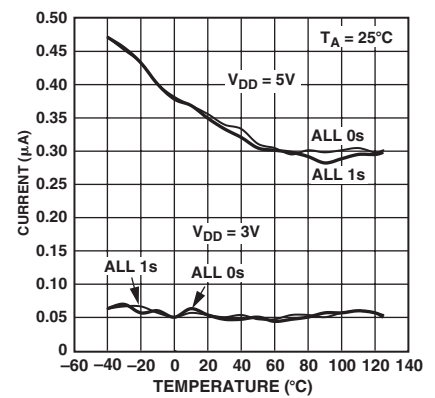

TPC 18. Supply Current vs. Temperature



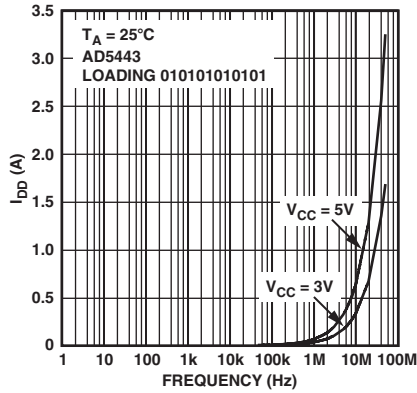

TPC 19. Supply Current vs. Update Rate

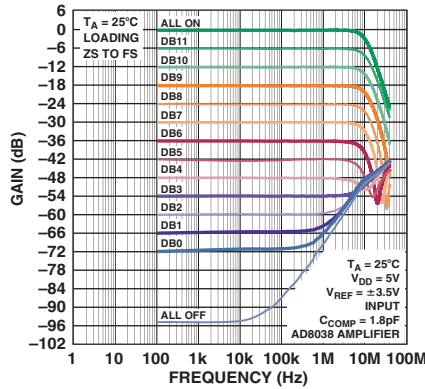

TPC 20. Reference Multiplying Bandwidth vs. Frequency and Code

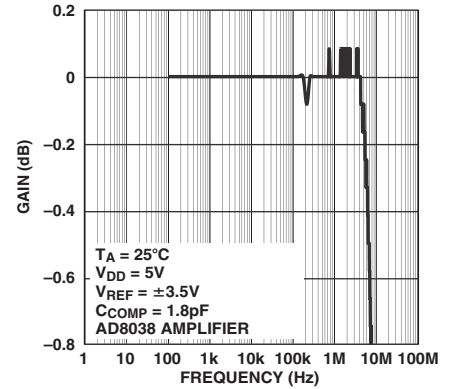

TPC 21. Reference Multiplying Bandwidth—All Ones Loaded

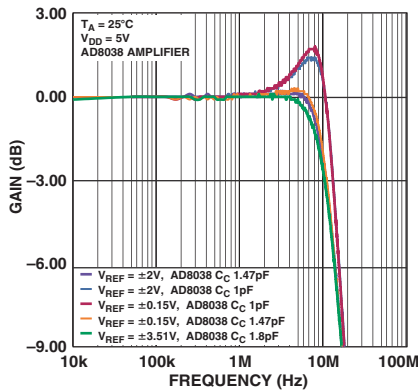

TPC 22. Reference Multiplying Bandwidth vs. Frequency and Compensation Capacitor

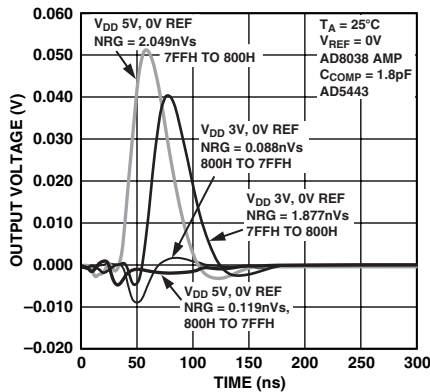

TPC 23. Midscale Transition  $V_{REF} = 0\text{ V}$

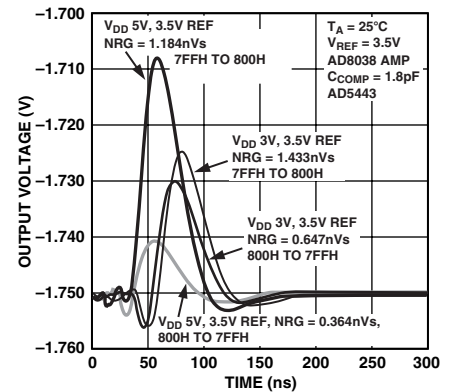

TPC 24. Midscale Transition  $V_{REF} = 3.5\text{ V}$

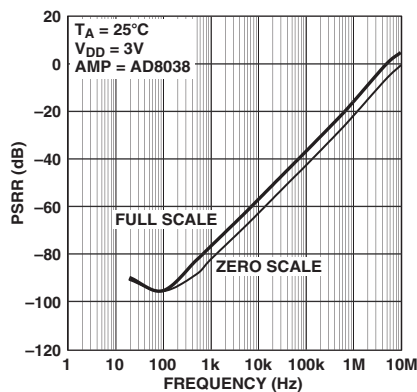

TPC 25. Power Supply Rejection vs. Frequency

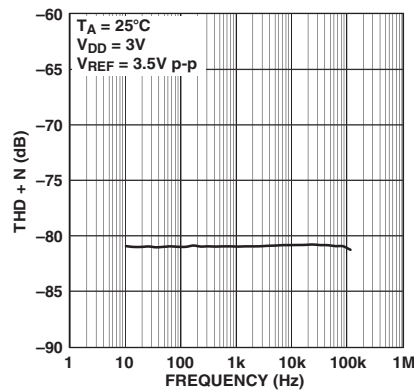

TPC 26. THD and Noise vs. Frequency

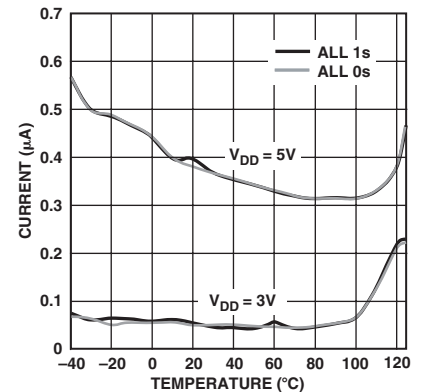

TPC 27. Supply Current vs. Temperature

# AD5426/AD5432/AD5443

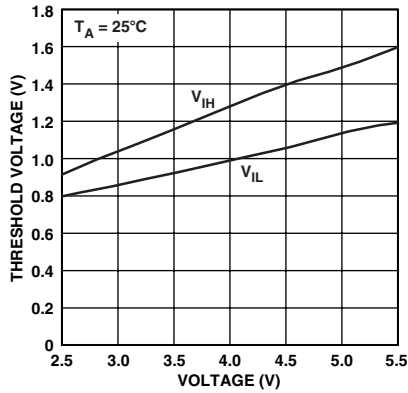

TPC 28. Threshold Voltages vs. Supply Voltage

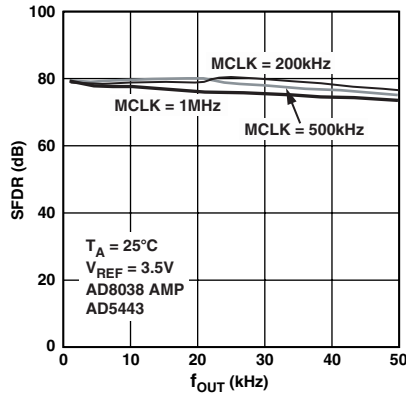

TPC 29. Wideband SFDR vs.  $f_{OUT}$  Frequency (AD5443)

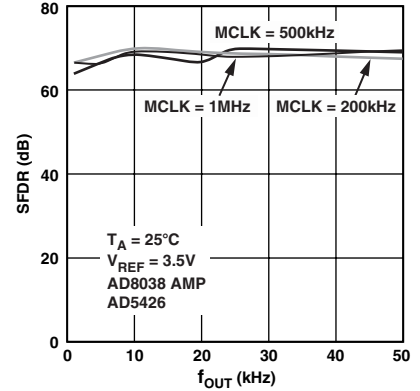

TPC 30. Wideband SFDR vs.  $f_{OUT}$  Frequency (AD5426)

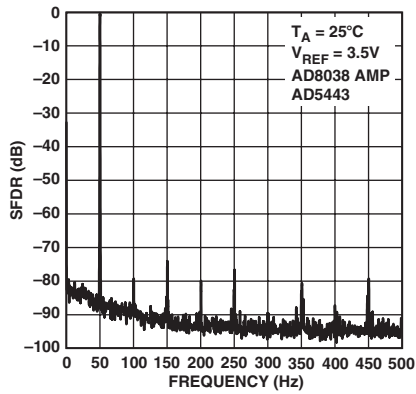

TPC 31. Wideband SFDR  $f_{OUT} = 50$  kHz, Update = 1 MHz

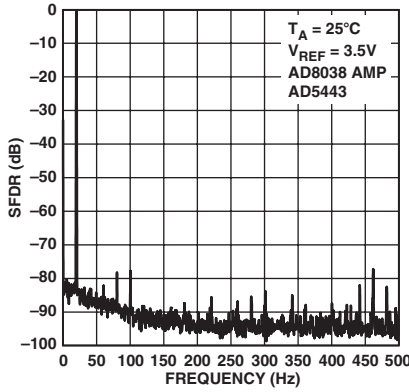

TPC 32. Wideband SFDR  $f_{OUT} = 20$  kHz, Update = 1 MHz

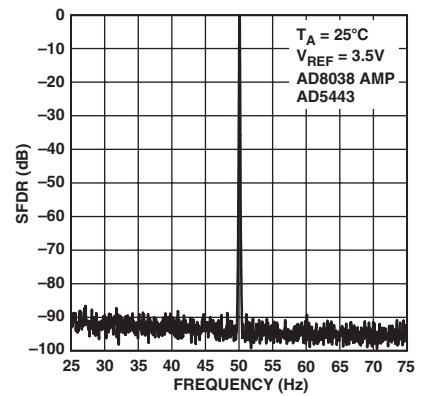

TPC 33. Narrowband ( $\pm 50\%$ ) SFDR  $f_{OUT} = 50$  kHz, Update = 1 MHz

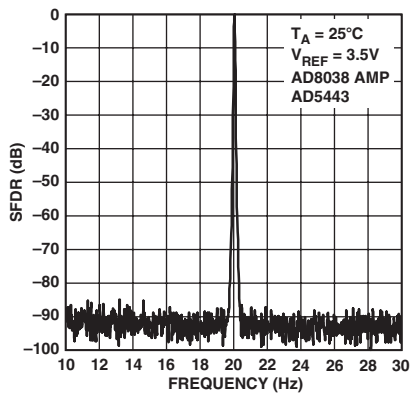

TPC 34. Narrowband ( $\pm 50\%$ ) SFDR  $f_{OUT} = 20$  kHz, Update = 1 MHz

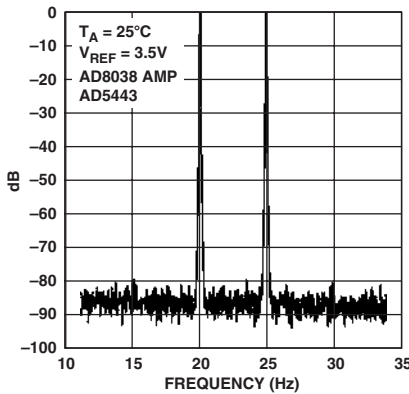

TPC 35. Narrowband ( $\pm 50\%$ ) IMD,  $f_{OUT} = 20$  kHz, 25 kHz, Update = 1 MHz

**TERMINOLOGY****Relative Accuracy**

Relative accuracy or endpoint nonlinearity is a measure of the maximum deviation from a straight line passing through the endpoints of the DAC transfer function. It is measured after adjusting for 0 and full scale and is normally expressed in LSBs or as a percentage of full-scale reading.

**Differential Nonlinearity**

Differential nonlinearity is the difference between the measured change and the ideal 1 LSB change between any two adjacent codes. A specified differential nonlinearity of  $-1$  LSB max over the operating temperature range ensures monotonicity.

**Gain Error**

Gain error or full-scale error is a measure of the output error between an ideal DAC and the actual device output. For these DACs, ideal maximum output is  $V_{REF} - 1$  LSB. Gain error of the DACs is adjustable to 0 with external resistance.

**Output Leakage Current**

Output leakage current is current that flows in the DAC ladder switches when these are turned off. For the  $I_{OUT1}$  terminal, it can be measured by loading all 0s to the DAC and measuring the  $I_{OUT1}$  current. Minimum current will flow in the  $I_{OUT2}$  line when the DAC is loaded with all 1s.

**Output Capacitance**

Capacitance from  $I_{OUT1}$  or  $I_{OUT2}$  to AGND.

**Output Current Settling Time**

This is the amount of time it takes for the output to settle to a specified level for a full scale input change. For these devices, it is specified with a  $100\ \Omega$  resistor to ground.

The settling time specification includes the digital delay from SYNC rising edge to the full-scale output charge.

**Digital to Analog Glitch Impulse**

The amount of charge injected from the digital inputs to the analog output when the inputs change state. This is normally specified as the area of the glitch in either pA-secs or nV-secs depending upon whether the glitch is measured as a current or voltage signal.

**Digital Feedthrough**

When the device is not selected, high frequency logic activity on the device digital inputs may be capacitively coupled through the device to show up as noise on the  $I_{OUT}$  pins and subsequently into the following circuitry. This noise is digital feedthrough.

**Multiplying Feedthrough Error**

This is the error due to capacitive feedthrough from the DAC reference input to the DAC  $I_{OUT1}$  terminal, when all 0s are loaded to the DAC.

**Total Harmonic Distortion (THD)**

The DAC is driven by an ac reference. The ratio of the rms sum of the harmonics of the DAC output to the fundamental value is the THD. Usually only the lower order harmonics are included, such as second to fifth.

$$THD = 20 \log \frac{\sqrt{V_2^2 + V_3^2 + V_4^2 + V_5^2}}{V_1}$$

**Digital Intermodulation Distortion**

Second-order intermodulation distortion (IMD) measurements are the relative magnitude of the  $f_a$  and  $f_b$  tones generated digitally by the DAC and the second-order products at  $2f_a - f_b$  and  $2f_b - f_a$ .

**Spurious-Free Dynamic Range (SFDR)**

It is the usable dynamic range of a DAC before spurious noise interferes or distorts the fundamental signal. SFDR is the measure of difference in amplitude between the fundamental and the largest harmonically or nonharmonically related spur from dc to full Nyquist bandwidth (half the DAC sampling rate, or  $f_s/2$ ). Narrow band SFDR is a measure of SFDR over an arbitrary window size, in this case 50% of the fundamental. Digital SFDR is a measure of the usable dynamic range of the DAC when the signal is digitally generated sine wave.

# AD5426/AD5432/AD5443

## DAC SECTION

The AD5426, AD5432, and AD5443 are 8-, 10-, and 12-bit current output DACs consisting of a standard inverting R-2R ladder configuration. A simplified diagram for the 8-bit AD5426 is shown in Figure 4. The feedback resistor  $R_{FB}$  has a value of  $R$ . The value of  $R$  is typically 10 k $\Omega$  (minimum 8 k $\Omega$  and maximum 12 k $\Omega$ ). If  $I_{OUT1}$  and  $I_{OUT2}$  are kept at the same potential, a constant current flows in each ladder leg, regardless of digital input code. Therefore, the input resistance presented at  $V_{REF}$  is always constant and nominally of value  $R$ . The DAC output ( $I_{OUT}$ ) is code-dependent, producing various resistances and capacitances. External amplifier choice should take into account the variation in impedance generated by the DAC on the amplifiers inverting input node.

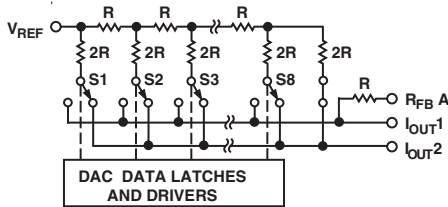

Figure 4. Simplified Ladder

Access is provided to the  $V_{REF}$ ,  $R_{FB}$ ,  $I_{OUT1}$ , and  $I_{OUT2}$  terminals of the DAC, making the device extremely versatile and allowing it to be configured in several different operating modes, for example, to provide a unipolar output, 4-quadrant multiplication in bipolar mode, or in single-supply modes of operation. Note that a matching switch is used in series with the internal  $R_{FB}$  feedback resistor. If users attempt to measure  $R_{FB}$ , power must be applied to  $V_{DD}$  to achieve continuity.

## SERIAL INTERFACE

The AD5426/AD5432/AD5443 have an easy to use 3-wire interface that is compatible with SPI/QSPI/MICROWIRE and DSP interface standards. Data is written to the device in 16 bit words. This 16-bit word consists of 4 control bits and either 8, 10, or 12 data bits as shown in Figure 5. The AD5443 uses all 12 bits of DAC data. The AD5432 uses 10 bits and ignores the 2 LSBs, while the AD5426 uses 8 bits and ignores the last 4 bits.

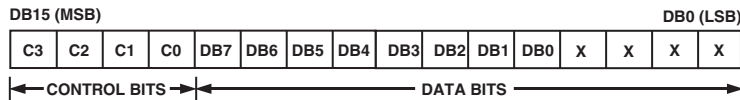

Figure 5a. AD5426 8-Bit Input Shift Register Contents

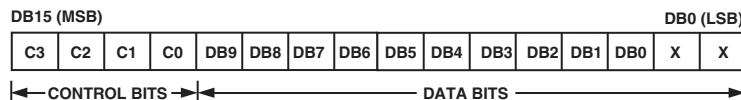

Figure 5b. AD5432 10-Bit Input Shift Register Contents

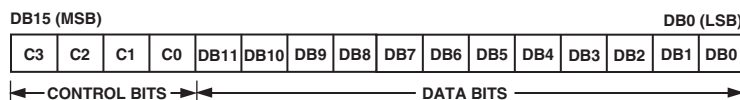

Figure 5c. AD5443 12-Bit Input Shift Register Contents

## Low Power Serial Interface

To minimize the power consumption of the device, the interface powers up fully only when the device is being written to, i.e., on the falling edge of  $\overline{SYNC}$ . The SCLK and  $D_{IN}$  input buffers are powered down on the rising edge of  $\overline{SYNC}$ .

## DAC Control Bits C3 to C0

Control Bits C3 to C0 allow control of various functions of the DAC as seen in Table I. Default settings of the DAC on power on are as follows:

Data clocked into shift register on falling clock edges; daisy-chain mode is enabled. Device powers on with zero-scale load to the DAC register and  $I_{OUT}$  lines.

The DAC control bits allow the user to adjust certain features on power-on, for example, daisy-chaining may be disabled if not in use, active clock edge may be changed to rising edge, and DAC output may be cleared to either zero or midscale. The user may also initiate a readback of the DAC register contents for verification purposes.

Table I. DAC Control Bits

C3	C2	C1	C0	Function Implemented
0	0	0	0	No Operation (Power-On Default)
0	0	0	1	Load and Update
0	0	1	0	Initiate Readback
0	0	1	1	Reserved
0	1	0	0	Reserved
0	1	0	1	Reserved
0	1	1	0	Reserved
0	1	1	1	Reserved
1	0	0	0	Reserved
1	0	0	1	Daisy-chain Disable
1	0	1	0	Clock Data to Shift Register On Rising Edge
1	0	1	1	Clear DAC Output to Zero
1	1	0	0	Clear DAC Output to Midscale
1	1	0	1	Reserved
1	1	1	0	Reserved
1	1	1	1	Reserved

## SYNC Function

SYNC is an edge-triggered input that acts as a frame synchronization signal and chip enable. Data can be transferred into the device only while SYNC is low. To start the serial data transfer, SYNC should be taken low observing the minimum SYNC falling to SCLK falling edge setup time,  $t_4$ .

## Daisy-Chain Mode

Daisy-chain is the default power-on mode. To disable the daisy-chain function, write 1001 to control word. In daisy-chain mode the internal gating on SCLK is disabled. The SCLK is continuously applied to the input shift register when SYNC is low. If more than 16 clock pulses are applied, the data ripples out of the shift register and appears on the SDO line. This data is clocked out on the rising edge of SCLK (this is the default, use the control word to change the active edge) and is valid for the next device on the falling edge (default). By connecting this line to the DIN input on the next device in the chain, a multidevice interface is constructed. 16 clock pulses are required for each device in the system. Therefore, the total number of clock cycles must equal 16N where N is the total number of devices in the chain. See the timing diagram in Figure 3.

When the serial transfer to all devices is complete, SYNC should be taken high. This prevents any further data being clocked into the input shift register. A burst clock containing the exact number of clock cycles may be used and SYNC taken high some time later. After the rising edge of SYNC, data is automatically transferred from each device's input shift register to the addressed DAC.

When control bits = 0000, the device is in No Operation mode. This may be useful in daisy-chain applications where the user does not want to change the settings of a particular DAC in the chain. Simply write 0000 to the control bits for that DAC and the following data bits will be ignored.

## Standalone Mode

After power-on, write 1001 to control word to disable daisy-chain mode. The first falling edge of SYNC resets a counter that counts the number of serial clocks to ensure the correct number of bits are shifted in and out of the serial shift registers. A rising edge on SYNC during a write causes the write cycle to be aborted.

After the falling edge of the 16th SCLK pulse, data will automatically be transferred from the input shift register to the DAC. For another serial transfer to take place, the counter must be reset by the falling edge of SYNC.

## CIRCUIT OPERATION

### Unipolar Mode

Using a single op amp, these devices can easily be configured to provide 2-quadrant multiplying operation or a unipolar output voltage swing as shown in Figure 6.

When an output amplifier is connected in unipolar mode, the output voltage is given by

$$V_{OUT} = -V_{REF} \times \frac{D}{2^n}$$

where  $D$  is the fractional representation of the digital word loaded to the DAC, and  $n$  is the number of bits.

$D = 0$  to 255 (8-bit AD5426)  
 $= 0$  to 1023 (10-bit AD5432)  
 $= 0$  to 4095 (12-bit AD5443)

Note that the output voltage polarity is opposite to the  $V_{REF}$  polarity for dc reference voltages.

These DACs are designed to operate with either negative or positive reference voltages. The  $V_{DD}$  power pin is used by only the internal digital logic to drive the DAC switches' on and off states.

These DACs are also designed to accommodate ac reference input signals in the range of  $-10$  V to  $+10$  V.

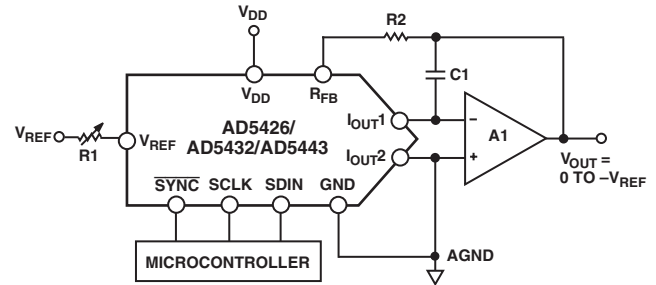

#### NOTES

1. R1 AND R2 USED ONLY IF GAIN ADJUSTMENT IS REQUIRED.
2. C1 PHASE COMPENSATION (1pF – 2pF) MAY BE REQUIRED IF A1 IS A HIGH SPEED AMPLIFIER.

Figure 6. Unipolar Operation

With a fixed 10 V reference, the circuit shown in Figure 6 will give a unipolar 0 V to  $-10$  V output voltage swing. When  $V_{IN}$  is an ac signal, the circuit performs 2-quadrant multiplication.

Table II shows the relationship between digital code and expected output voltage for unipolar operation (AD5426, 8-bit device).

Table II. Unipolar Code Table

Digital Input	Analog Output (V)
1111 1111	$-V_{REF}$ (255/256)
1000 0000	$-V_{REF}$ (128/256) = $-V_{REF}/2$
0000 0001	$-V_{REF}$ (1/256)
0000 0000	$-V_{REF}$ (0/256) = 0

### Bipolar Operation

In some applications, it may be necessary to generate full 4-quadrant multiplying operation or a bipolar output swing. This can be easily accomplished by using another external amplifier and some external resistors as shown in Figure 7. In this circuit, the second amplifier A2 provides a gain of 2. Biasing the external amplifier with an offset from the reference voltage results in full 4-quadrant multiplying operation. The transfer function of this circuit shows that both negative and positive output voltages are created as the input data ( $D$ ) is incremented from code zero ( $V_{OUT} = -V_{REF}$ ) to midscale ( $V_{OUT} = 0$  V) to full scale ( $V_{OUT} = +V_{REF}$ ).

$$V_{OUT} = \left( V_{REF} \times \frac{D}{2^{n-1}} \right) - V_{REF}$$

where  $D$  is the fractional representation of the digital word loaded to the DAC and  $n$  is the resolution of the DAC.

$D = 0$  to 255 (8-bit AD5426)  
 $= 0$  to 1023 (10-bit AD5432)  
 $= 0$  to 4095 (12-bit AD5443)

When  $V_{IN}$  is an ac signal, the circuit performs 4-quadrant multiplication.

# AD5426/AD5432/AD5443

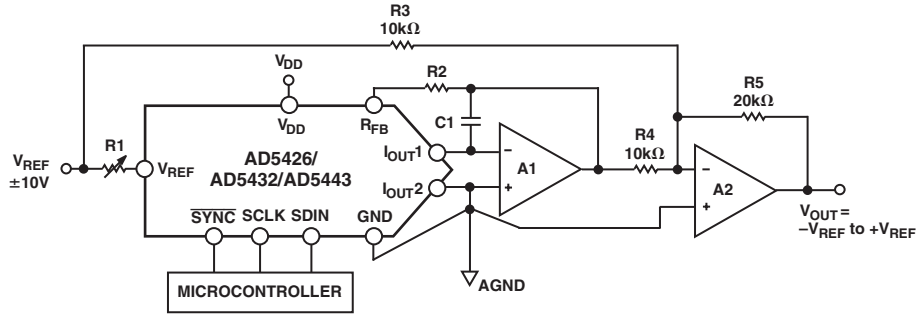

## NOTES

1. R1 AND R2 ARE USED ONLY IF GAIN ADJUSTMENT IS REQUIRED. ADJUST R1 FOR  $V_{OUT} = 0$  V WITH CODE 10000000 LOADED TO DAC.
2. MATCHING AND TRACKING IS ESSENTIAL FOR RESISTOR PAIRS R3 AND R4.
3. C1 PHASE COMPENSATION (1pF–2pF) MAY BE REQUIRED IF A1/A2 IS A HIGH SPEED AMPLIFIER.

Figure 7. Bipolar Operation

Table III shows the relationship between digital code and the expected output voltage for bipolar operation (AD5426, 8-bit device).

Table III. Bipolar Code Table

Digital Input	Analog Output (V)
1111 1111	$+V_{REF}$ (127/128)
1000 0000	0
0000 0001	$-V_{REF}$ (127/128)
0000 0000	$-V_{REF}$ (128/128)

## Stability

In the I-to-V configuration, the  $I_{OUT}$  of the DAC and the inverting node of the op amp must be connected as close as possible, and proper PCB layout techniques must be employed. Since every code change corresponds to a step function, gain peaking may occur if the op amp has limited GBP and there is excessive parasitic capacitance at the inverting node. This parasitic capacitance introduces a pole into the open-loop response which can cause ringing or instability in closed-loop applications.

An optional compensation capacitor, C1 can be added in parallel with  $R_{FB}$  for stability as shown in Figures 6 and 7. Too small a value of C1 can produce ringing at the output, while too large a value can adversely affect the settling time. C1 should be found empirically but 1 pF to 2 pF is generally adequate for compensation.

## SINGLE-SUPPLY APPLICATIONS

### Current Mode Operation

These DACs are specified and tested to guarantee operation in single-supply applications. Figure 8 shows a typical circuit for operation with a single 3.0 V to 5 V supply. In the current mode circuit of Figure 8,  $I_{OUT2}$  and hence  $I_{OUT1}$  is biased positive by an amount applied to  $V_{BIAS}$ .

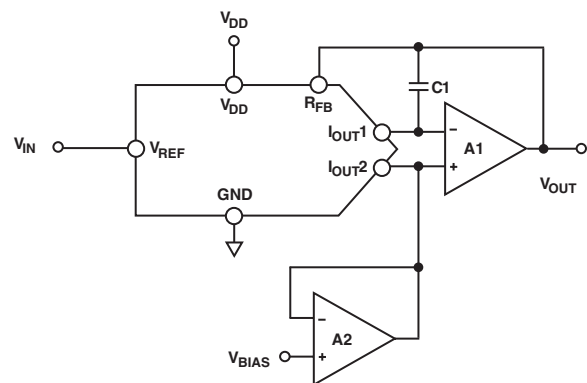

## NOTES

1. ADDITIONAL PINS OMITTED FOR CLARITY
2. C1 PHASE COMPENSATION (1pF–2pF) MAY BE REQUIRED IF A1 IS A HIGH SPEED AMPLIFIER.

Figure 8. Single-Supply Current Mode Operation

In this configuration, the output voltage is given by

$$V_{OUT} = \left\{ D \times \left( R_{FB} / R_{DAC} \right) \times \left( V_{BIAS} - V_{IN} \right) \right\} + V_{BIAS}$$

As D varies from 0 to 255 (AD5426), 1023 (AD5432) or 4095 (AD5443), the output voltage varies from

$$V_{OUT} = V_{BIAS} \text{ to } V_{OUT} = 2 V_{BIAS} - V_{IN}$$

$V_{BIAS}$  should be a low impedance source capable of sinking and sourcing all possible variations in current at the  $I_{OUT2}$  terminal without any problems.

It is important to note that  $V_{IN}$  is limited to low voltages because the switches in the DAC ladder no longer have the same source-drain drive voltage. As a result, their on resistance differs, which degrades the linearity of the DAC. See TPCs 10 to 15.

### Voltage Switching Mode of Operation

Figure 9 shows these DACs operating in the voltage-switching mode. The reference voltage,  $V_{IN}$ , is applied to the  $I_{OUT1}$  pin,  $I_{OUT2}$  is connected to AGND, and the output voltage is available at the  $V_{REF}$  terminal. In this configuration, a positive reference voltage results in a positive output voltage making single-supply operation possible. The output from the DAC is voltage at a constant impedance (the DAC ladder resistance), thus an op amp is necessary to buffer the output voltage. The reference input no longer sees a constant input impedance, but one that varies with code. So, the voltage input should be driven from a low impedance source.

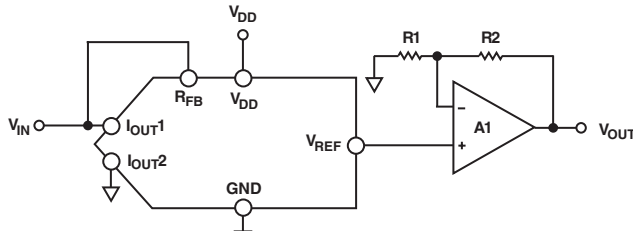

- NOTES  
 1. ADDITIONAL PINS OMITTED FOR CLARITY  
 2. C1 PHASE COMPENSATION (1pF–2pF) MAY BE REQUIRED IF A1 IS A HIGH SPEED AMPLIFIER.

Figure 9. Single-Supply Voltage Switching Mode Operation

Also,  $V_{IN}$  must not go negative by more than 0.3 V or an internal diode will turn on, exceeding the max ratings of the device. In this type of application, the full range of multiplying capability of the DAC is lost.

### POSITIVE OUTPUT VOLTAGE

Note that the output voltage polarity is opposite to the  $V_{REF}$  polarity for dc reference voltages. To achieve a positive voltage output, an applied negative reference to the input of the DAC is preferred over the output inversion through an inverting amplifier because of the resistor tolerance errors. To generate a negative reference, the reference can be level shifted by an op amp such that the  $V_{OUT}$  and GND pins of the reference become the virtual ground and  $-2.5$  V, respectively, as shown in Figure 10.

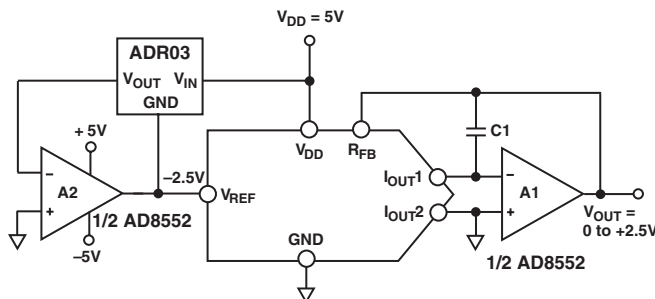

- NOTES  
 1. ADDITIONAL PINS OMITTED FOR CLARITY  
 2. C1 PHASE COMPENSATION (1pF–2pF) MAY BE REQUIRED IF A1 IS A HIGH SPEED AMPLIFIER.

Figure 10. Positive Voltage Output with Minimum of Components

### ADDING GAIN

In applications where the output voltage is required to be greater than  $V_{IN}$ , gain can be added with an additional external amplifier or it can also be achieved in a single stage. It is important to consider the effect of temperature coefficients of the thin film

resistors of the DAC. Simply placing a resistor in series with the  $R_{FB}$  resistor will cause mismatches in the temperature coefficients, resulting in larger gain temperature coefficient errors. Instead, the circuit of Figure 11 is a recommended method of increasing the gain of the circuit.  $R1$ ,  $R2$ , and  $R3$  should all have similar temperature coefficients, but they need not match the temperature coefficients of the DAC. This approach is recommended in circuits where gains of greater than 1 are required.

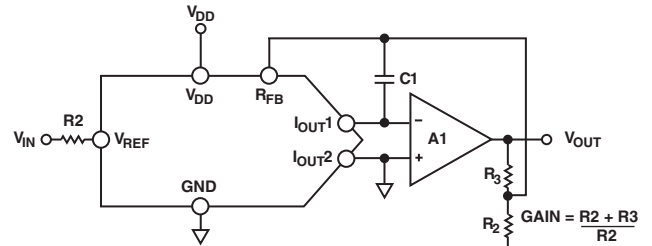

- NOTES  
 1. ADDITIONAL PINS OMITTED FOR CLARITY  
 2. C1 PHASE COMPENSATION (1pF–2pF) MAY BE REQUIRED IF A1 IS A HIGH SPEED AMPLIFIER.

Figure 11. Increasing Gain of Current Output DAC

### USED AS A DIVIDER OR PROGRAMMABLE GAIN ELEMENT

Current steering DACs are very flexible and lend themselves to many different applications. If this type of DAC is connected as the feedback element of an op amp and  $R_{FB}$  is used as the input resistor as shown in Figure 12, then the output voltage is inversely proportional to the digital input fraction  $D$ .

For  $D = 1-2^{-n}$  the output voltage is

$$V_{OUT} = -V_{IN}/D = -V_{IN}/(1-2^{-n})$$

As  $D$  is reduced, the output voltage increases. For small values of the digital fraction  $D$ , it is important to ensure that the amplifier does not saturate and also that the required accuracy is met. For example, an 8-bit DAC driven with the binary code 0x10 (00010000), i.e., 16 decimal, in the circuit of Figure 12 should cause the output voltage to be  $16 \times V_{IN}$ . However, if the DAC has a linearity specification of  $\pm 0.5$  LSB then  $D$  can in fact have the weight anywhere in the range  $15.5/256$  to  $16.5/256$  so that the possible output voltage will be in the range  $15.5 V_{IN}$  to  $16.5 V_{IN}$ —an error of +3% even though the DAC itself has a maximum error of 0.2%.

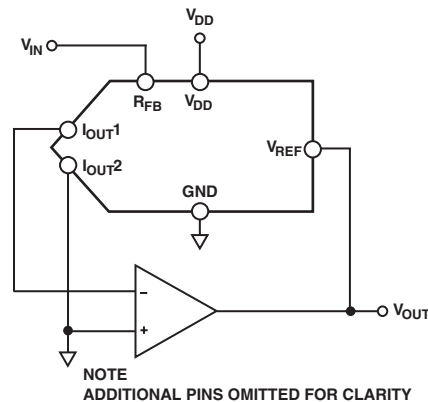

- NOTE  
 ADDITIONAL PINS OMITTED FOR CLARITY

Figure 12. Current Steering DAC Used as a Divider or Programmable Gain Element

# AD5426/AD5432/AD5443

DAC leakage current is also a potential error source in divider circuits. The leakage current must be counterbalanced by an opposite current supplied from the op amp through the DAC. Since only a fraction  $D$  of the current into the  $V_{REF}$  terminal is routed to the  $I_{OUT1}$  terminal, the output voltage has to change as follows:

$$\text{Output Error Voltage Due to DAC Leakage} = (\text{Leakage} \times R)/D$$

where  $R$  is the DAC resistance at the  $V_{REF}$  terminal. For a DAC leakage current of 10 nA,  $R = 10 \text{ k}\Omega$  and a gain (i.e.,  $1/D$ ) of 16 the error voltage is 1.6 mV.

## REFERENCE SELECTION

When selecting a reference for use with the AD5426 series of current output DACs, pay attention to the references output voltage temperature coefficient specification. This parameter not only affects the full-scale error, but can also affect the linearity (INL and DNL) performance. The reference temperature coefficient should be consistent with the system accuracy specifications. For example, an 8-bit system required to hold its overall specification to within 1 LSB over the temperature range  $0^\circ\text{C}$  to  $50^\circ\text{C}$  dictates that the maximum *system drift* with temperature should be less than  $78 \text{ ppm}/^\circ\text{C}$ . A 12-bit system with the same temperature range to overall specification within 2 LSBs requires a maximum drift of  $10 \text{ ppm}/^\circ\text{C}$ . By choosing a precision reference with low output temperature coefficient, this error source can be minimized. Table IV suggests some references available from Analog Devices that are suitable for use with this range of current output DACs.

## AMPLIFIER SELECTION

The primary requirement for the current-steering mode is an amplifier with low input bias currents and low input offset voltage. The input offset voltage of an op amp is multiplied by the variable gain (due to the code dependent output resistance of the DAC) of the circuit. A change in this noise gain between two adjacent digital fractions produces a step change in the output voltage due to the amplifier's input offset voltage. This output voltage change is superimposed on the desired change in output between the two codes and gives rise to a differential linearity error, which, if large enough, could cause the DAC to be nonmonotonic. In general, the input offset voltage should be a fraction ( $\sim <1/4$ ) of an LSB to ensure monotonic behavior when stepping through codes.

The input bias current of an op amp also generates an offset at the voltage output as a result of the bias current flowing in the feedback resistor  $R_{FB}$ . Most op amps have input bias currents low enough to prevent any significant errors in 12-bit applications.

Common-mode rejection of the op amp is important in voltage switching circuits since it produces a code dependent error at the voltage output of the circuit. Most op amps have adequate common-mode rejection for use at 8-, 10-, and 12-bit resolution.

Provided the DAC switches are driven from true wideband low impedance sources ( $V_{IN}$  and AGND), they settle quickly. Consequently, the slew rate and settling time of a voltage switching DAC circuit is determined largely by the output op amp. To obtain minimum settling time in this configuration, it is important to minimize capacitance at the  $V_{REF}$  node (voltage output node in this application) of the DAC. This is done by using low inputs capacitance buffer amplifiers and careful board design.

**Table IV. Suitable ADI Precision References Recommended for Use with AD5426/AD5432/AD5443 DACs**

Part No.	Output Voltage	Initial Tolerance	Temperature Drift	0.1 Hz to 10 Hz Noise	Package
ADR01	10 V	0.1%	3 ppm/ $^\circ\text{C}$	20 $\mu\text{V}$ p-p	SC70, TSOT, SOIC
ADR02	5 V	0.1%	3 ppm/ $^\circ\text{C}$	10 $\mu\text{V}$ p-p	SC70, TSOT, SOIC
ADR03	2.5 V	0.2%	3 ppm/ $^\circ\text{C}$	10 $\mu\text{V}$ p-p	SC70, TSOT, SOIC
ADR425	5 V	0.04%	3 ppm/ $^\circ\text{C}$	3.4 $\mu\text{V}$ p-p	MSOP, SOIC

**Table V. Some Precision ADI Op Amps Suitable for Use with AD5426/AD5432/AD5443 DACs**

Part No.	Max Supply Voltage (V)	$V_{OS(max)}$ ( $\mu\text{V}$ )	$I_B(max)$ (nA)	GBP (MHz)	Slew Rate (V/ $\mu\text{s}$ )
OP97	$\pm 20$	25	0.1	0.9	0.2
OP1177	$\pm 18$	60	2	1.3	0.7
AD8551	+6	5	0.05	1.5	0.4

**Table VI. Listing of Some High Speed ADI Op Amps Suitable for Use with AD5426/AD5432/AD5443 DACs**

Part No.	Max Supply Voltage (V)	BW @ $A_{CL}$ (MHz)	Slew Rate (V/ $\mu\text{s}$ )	$V_{OS(max)}$ ( $\mu\text{V}$ )	$I_B(max)$ (nA)
AD8065	$\pm 12$	145	180	1500	0.01
AD8021	$\pm 12$	200	100	1000	1000
AD8038	$\pm 5$	350	425	3000	0.75
AD9631	$\pm 5$	320	1300	10000	7000



Most single-supply circuits include ground as part of the analog signal range, which in turns requires an amplifier that can handle rail-to-rail signals, there is a large range of single-supply amplifiers available from Analog Devices.

### MICROPROCESSOR INTERFACING

Microprocessor interfacing to this family of DACs is via a serial bus that uses standard protocol compatible with microcontrollers and DSP processors. The communications channel is a 3-wire interface consisting of a clock signal, a data signal, and a synchronization signal. The AD5426/AD5432/AD5443 requires a 16-bit word with the default being data valid on the falling edge of SCLK, but this is changeable via the control bits in the data-word.

#### ADSP-21xx to AD5426/AD5432/AD5443 Interface

The ADSP-21xx family of DSPs are easily interface to this family of DACs without extra glue logic. Figure 13 shows an example of an SPI interface between the DAC and the ADSP-2191M. SCK of the DSP drives the serial data line, DIN. SYNC is driven from one of the port lines, in this case SPIxSEL.

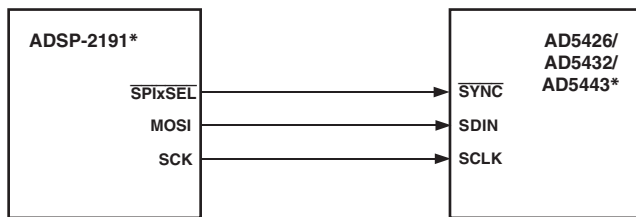

\*ADDITIONAL PINS OMITTED FOR CLARITY

Figure 13. ADSP-2191 SPI to AD5426/AD5432/AD5443 Interface

A serial interface between the DAC and DSP SPORT is shown in Figure 14. In this interface example, SPORT0 is used to transfer data to the DAC shift register. Transmission is initiated by writing a word to the Tx register after the SPORT has been enabled. In a write sequence, data is clocked out on each rising edge of the DSP's serial clock and clocked into the DAC input shift register on the falling edge of its SCLK. The update of the DAC output takes place on the rising edge of the SYNC signal.

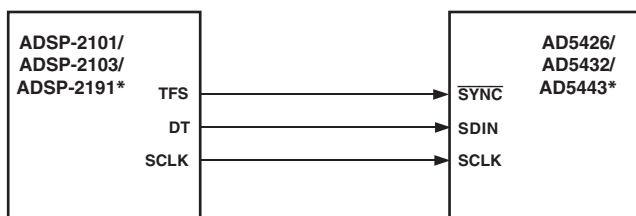

\*ADDITIONAL PINS OMITTED FOR CLARITY

Figure 14. ADSP-2101/ADSP-2103/ADSP-2191 SPORT to AD5426/AD5432/AD5443 Interface

Communication between two devices at a given clock speed is possible when the following specs are compatible: frame sync delay and frame sync setup and hold, data delay and data setup and hold, and SCLK width. The DAC interface expects a  $t_4$  (SYNC falling edge to SCLK falling edge setup time) of 13 ns minimum. Consult the ADSP-21xx User Manual for information on clock and frame sync frequencies for the SPORT register.

The SPORT control register should be set up as follows:

- TFSW = 1, Alternate Framing
- INVTFS = 1, Active Low Frame Signal
- DTYPE = 00, Right Justify Data
- ISCLK = 1, Internal Serial Clock
- TFSR = 1, Frame Every Word
- ITFS = 1, Internal Framing Signal
- SLEN = 1111, 16-Bit Data-Word

#### 80C51/80L51 to AD5426/AD5432/AD5443 Interface

A serial interface between the DAC and the 8051 is shown in Figure 15. TxD of the 8051 drives SCLK of the DAC serial interface, while RxD drives the serial data line, DIN. P3.3 is a bit-programmable pin on the serial port and is used to drive SYNC. When data is to be transmitted to the switch, P3.3 is taken low. The 80C51/80L51 transmits data only in 8-bit bytes; thus, only eight falling clock edges occur in the transmit cycle. To load data correctly to the DAC, P3.3 is left low after the first eight bits are transmitted, and a second write cycle is initiated to transmit the second byte of data. Data on RxD is clocked out of the microcontroller on the rising edge of TxD and is valid on the falling edge. As a result, no glue logic is required between the DAC and microcontroller interface. P3.3 is taken high following the completion of this cycle. The 8051 provides the LSB of its SBUF register as the first bit in the data stream. The DAC input register requires its data with the MSB as the first bit received. The transmit routine should take this into account.

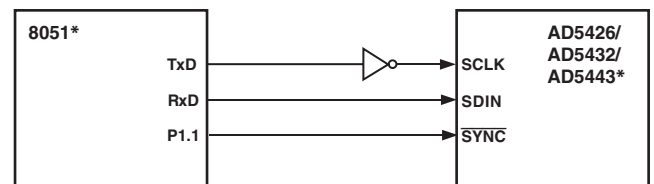

\*ADDITIONAL PINS OMITTED FOR CLARITY

Figure 15. 80C51/80L51 to AD5426/AD5432/AD5443 Interface

# AD5426/AD5432/AD5443

## MC68HC11 Interface to AD5426/AD5432/AD5443 Interface

Figure 16 shows an example of a serial interface between the DAC and the MC68HC11 microcontroller. The serial peripheral interface (SPI) on the MC68HC11 is configured for master mode (MSTR = 1), clock polarity bit (CPOL) = 0, and the clock phase bit (CPHA) = 1. The SPI is configured by writing to the SPI control register (SPCR)—see the 68HC11 User Manual. SCK of the 68HC11 drives the SCLK of the DAC interface, the MOSI output drives the serial data line ( $D_{IN}$ ) of the AD5516. The  $\overline{\text{SYNC}}$  signal is derived from a port line (PC7). When data is being transmitted to the AD5516, the  $\overline{\text{SYNC}}$  line is taken low (PC7). Data appearing on the MOSI output is valid on the falling edge of SCK. Serial data from the 68HC11 is transmitted in 8-bit bytes with only eight falling clock edges occurring in the transmit cycle. Data is transmitted MSB first. To load data to the DAC, PC7 is left low after the first eight bits are transferred, and a second serial write operation is performed to the DAC. PC7 is taken high at the end of this procedure.

If the user wants to verify the data previously written to the input shift register, the SDO line could be connected to MISO of the MC68HC11, and with  $\overline{\text{SYNC}}$  low, the shift register would clock data out on the rising edges of SCLK.

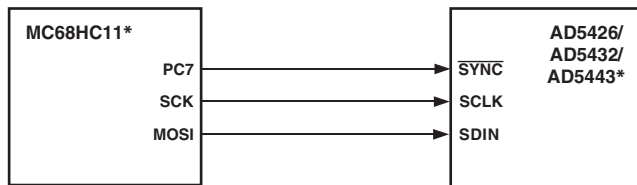

\*ADDITIONAL PINS OMITTED FOR CLARITY

Figure 16. 68HC11/68L11 to AD5426/AD5432/AD5443 Interface

## MICROWIRE to AD5426/AD5432/AD5443 Interface

Figure 17 shows an interface between the DAC and any MICROWIRE compatible device. Serial data is shifted out on the falling edge of the serial clock, SK, and is clocked into the DAC input shift register on the rising edge of SK, which corresponds to the falling edge of the DACs SCLK.

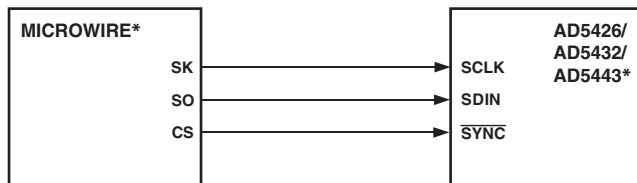

\*ADDITIONAL PINS OMITTED FOR CLARITY

Figure 17. MICROWIRE to AD5426/AD5432/AD5443 Interface

## PIC16C6x/7x to AD5426/AD5432/AD5443

The PIC16C6x/7x synchronous serial port (SSP) is configured as an SPI master with the clock polarity bit (CKP) = 0. This is done by writing to the synchronous serial port control register (SSPCON). See the PIC16/17 Microcontroller User Manual. In this example, I/O port RA1 is being used to provide a  $\overline{\text{SYNC}}$  signal and to enable the serial port of the DAC. This microcontroller transfers only eight bits of data during each serial transfer operation; therefore, two consecutive write operations are required. Figure 18 shows the connection diagram.

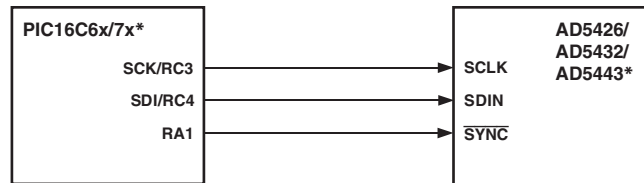

\*ADDITIONAL PINS OMITTED FOR CLARITY

Figure 18. PIC16C6x/7x to AD5426/AD5432/AD5443 Interface

## PCB LAYOUT AND POWER SUPPLY DECOUPLING

In any circuit where accuracy is important, careful consideration of the power supply and ground return layout helps to ensure the rated performance. The printed circuit board on which the AD5426/AD5432/AD5443 is mounted should be designed so that the analog and digital sections are separated, and confined to certain areas of the board. If the DAC is in a system where multiple devices require an AGND-to-DGND connection, the connection should be made at one point only. The star ground point should be established as close as possible to the device.

These DACs should have ample supply bypassing of 10  $\mu\text{F}$  in parallel with 0.1  $\mu\text{F}$  on the supply located as close to the package as possible, ideally right up against the device. The 0.1  $\mu\text{F}$  capacitor should have low effective series resistance (ESR) and effective series inductance (ESI), such as the common ceramic types that provide a low impedance path to ground at high frequencies, to handle transient currents due to internal logic switching. Low ESR 1  $\mu\text{F}$  to 10  $\mu\text{F}$  tantalum or electrolytic capacitors should also be applied at the supplies to minimize transient disturbance and filter out low frequency ripple.

Fast switching signals such as clocks should be shielded with digital ground to avoid radiating noise to other parts of the board, and should never be run near the reference inputs.

Avoid crossover of digital and analog signals. Traces on opposite sides of the board should run at right angles to each other. This reduces the effects of feedthrough through the board. A microstrip technique is by far the best, but not always possible with a double-sided board. In this technique, the component side of the board is dedicated to ground plane while signal traces are placed on the solder side.

It is good practice to employ compact, minimum lead length PCB layout design. Leads to the input should be as short as possible to minimize IR drops and stray inductance.

The PCB metal traces between  $V_{\text{REF}}$  and  $R_{\text{FB}}$  should also be matched to minimize gain error. To maximize on high frequency performance, the I-to-V amplifier should be located as close to the device as possible.

## EVALUATION BOARD FOR THE AD5426/AD5432/AD5443 SERIES OF DACS

The board consists of a 12-bit AD5443 and a current to voltage amplifier AD8065. Included on the evaluation board is a 10 V reference ADR01. An external reference may also be applied via an SMB input.

The evaluation kit consists of a CD-ROM with self-installing PC software to control the DAC. The software simply allows the user to write a code to the device.

## OPERATING THE EVALUATION BOARD

### Power Supplies

The board requires  $\pm 12$  V, and +5 V supplies. The +12 V  $V_{DD}$  and  $V_{SS}$  are used to power the output amplifier, while the +5 V is used to power the DAC ( $V_{DD1}$ ) and transceivers ( $V_{CC}$ ).

Both supplies are decoupled to their respective ground plane with 10  $\mu$ F tantalum and 0.1  $\mu$ F ceramic capacitors.

Link1 (LK1) is provided to allow selection between the on-board reference (ADR01) or an external reference applied through J2. For the AD5426/AD5432/AD5443 use Link2 in the SDO position.

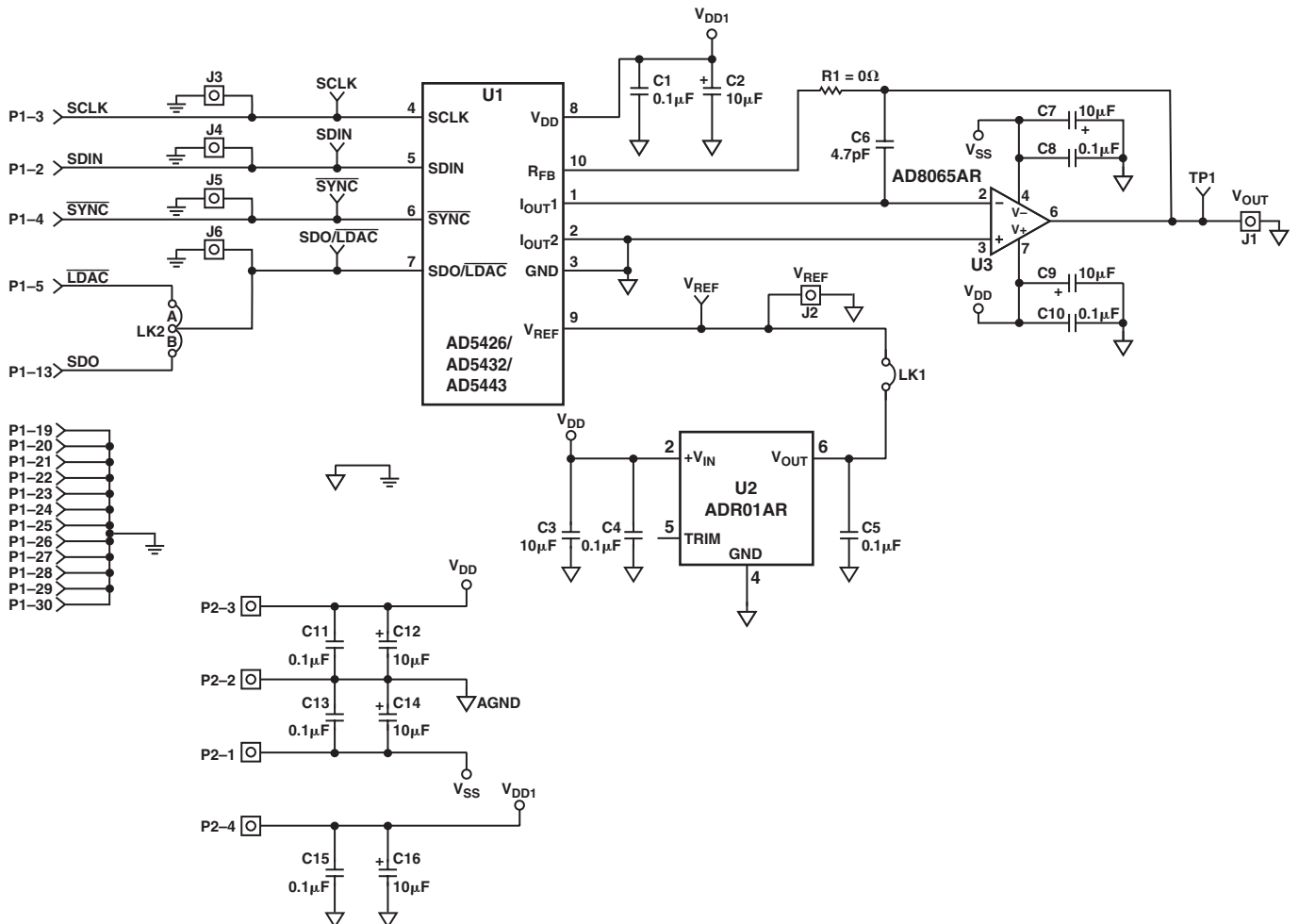

Figure 19. Schematic of AD5426/AD5432/AD5443 Evaluation Board

# AD5426/AD5432/AD5443

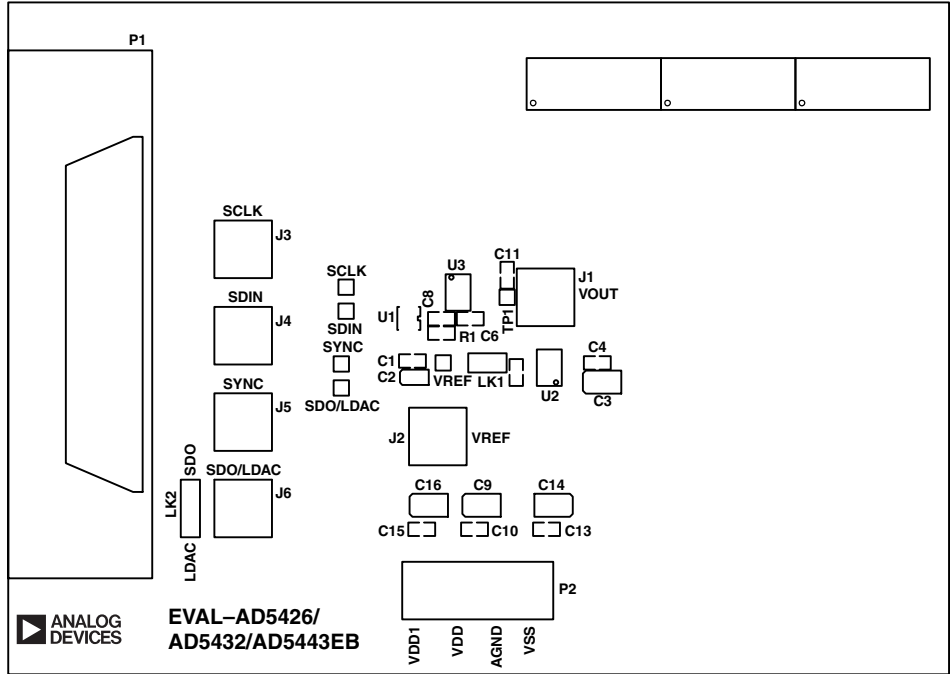

Figure 20. Silkscreen—Component Side View (Top Layer)

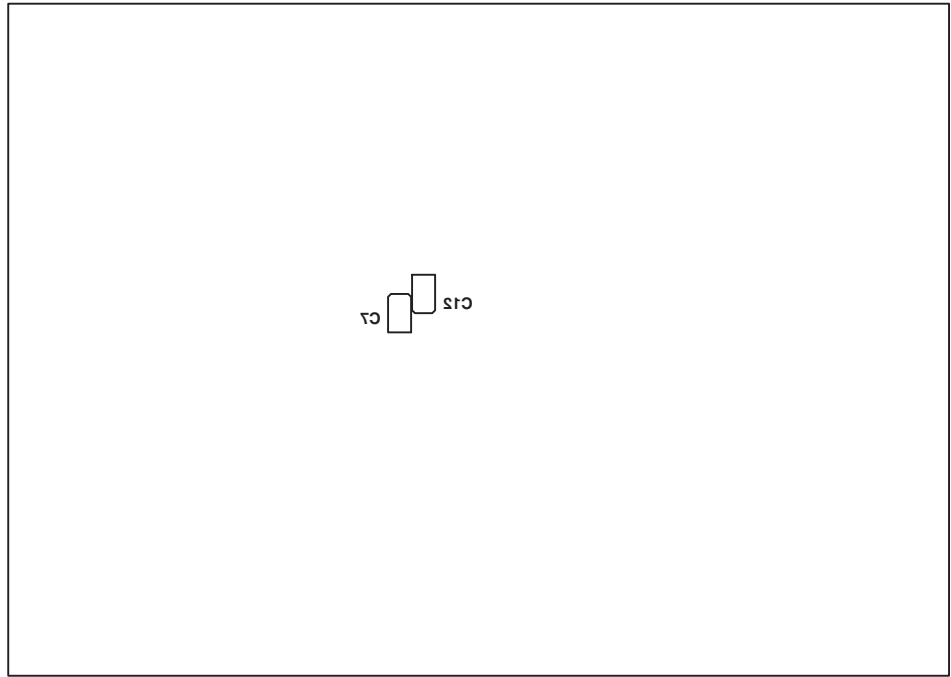

Figure 21. Silkscreen—Component Side View (Bottom Layer)

## Overview of AD54xx Devices

Part No.	Resolution	No. DACs	INL	t <sub>s</sub> max	Interface	Package	Features
AD5403*	8	2	±0.25	60 ns	Parallel	CP-40	10 MHz Bandwidth, 10 ns $\overline{\text{CS}}$ Pulse Width, 4-Quadrant Multiplying Resistors
AD5410*	8	1	±0.25	100 ns	Serial	RU-16	10 MHz Bandwidth, 50 MHz Serial, 4-Quadrant Multiplying Resistors
AD5413*	8	2	±0.25	100 ns	Serial	RU-24	10 MHz Bandwidth, 50 MHz Serial, 4-Quadrant Multiplying Resistors
AD5424	8	1	±0.25	60 ns	Parallel	RU-16, CP-20	10 MHz Bandwidth, 17 ns $\overline{\text{CS}}$ Pulse Width
AD5425	8	1	±0.25	100 ns	Serial	RM-10	Byte Load, 10 MHz Bandwidth, 50 MHz Serial
AD5426	8	1	±0.25	100 ns	Serial	RM-10	10 MHz Bandwidth, 50 MHz Serial
AD5428	8	2	±0.25	60 ns	Parallel	RU-20	10 MHz Bandwidth, 17 ns $\overline{\text{CS}}$ Pulse Width
AD5429	8	2	±0.25	100 ns	Serial	RU-10	10 MHz Bandwidth, 50 MHz Serial
AD5450	8	1	±0.25	100 ns	Serial	RJ-8	10 MHz Bandwidth, 50 MHz Serial
AD5404*	10	2	±0.5	70 ns	Parallel	CP-40	10 MHz Bandwidth, 17 ns $\overline{\text{CS}}$ Pulse Width, 4-Quadrant Multiplying Resistors
AD5411*	10	1	±0.5	110 ns	Serial	RU-16	10 MHz Bandwidth, 50 MHz Serial, 4-Quadrant Multiplying Resistors
AD5414*	10	2	±0.5	110 ns	Serial	RU-24	10 MHz Bandwidth, 50 MHz Serial, 4-Quadrant Multiplying Resistors
AD5432	10	1	±0.5	110 ns	Serial	RM-10	10 MHz Bandwidth, 50 MHz Serial
AD5433	10	1	±0.5	70 ns	Parallel	RU-20, CP-20	10 MHz Bandwidth, 17 ns $\overline{\text{CS}}$ Pulse Width
AD5439	10	2	±0.5	110 ns	Serial	RU-16	10 MHz Bandwidth, 50 MHz Serial
AD5440	10	2	±0.5	70 ns	Parallel	RU-24	10 MHz Bandwidth, 17 ns $\overline{\text{CS}}$ Pulse Width
AD5451	10	1	±0.25	110 ns	Serial	RJ-8	10 MHz Bandwidth, 50 MHz Serial
AD5405	12	2	±1	120 ns	Parallel	CP-40	10 MHz Bandwidth, 17 ns $\overline{\text{CS}}$ Pulse Width, 4-Quadrant Multiplying Resistors
AD5412*	12	1	±1	160 ns	Serial	RU-16	10 MHz Bandwidth, 50 MHz Serial, 4-Quadrant Multiplying Resistors
AD5415	12	2	±1	160 ns	Serial	RU-24	10 MHz Bandwidth, 50 MHz Serial, 4-Quadrant Multiplying Resistors
AD5443	12	1	±1	160 ns	Serial	RM-10	10 MHz Bandwidth, 50 MHz Serial
AD5444	12	1	±0.5	160 ns	Serial	RM-10	10 MHz Bandwidth, 50 MHz Serial
AD5445	12	1	±1	120 ns	Parallel	RU-20, CP-20	10 MHz Bandwidth, 17 ns $\overline{\text{CS}}$ Pulse Width
AD5446	14	1	±2	180 ns	Serial	RM-10	10 MHz Bandwidth, 50 MHz Serial
AD5447	12	2	±1	120 ns	Parallel	RU-24	10 MHz Bandwidth, 17 ns $\overline{\text{CS}}$ Pulse Width
AD5449	12	2	±1	160 ns	Serial	RU-16	10 MHz Bandwidth, 17 ns $\overline{\text{CS}}$ Pulse Width
AD5452	12	1	±0.5	160 ns	Serial	RJ-8, RM-8	10 MHz Bandwidth, 50 MHz Serial
AD5453	14	1	±2	180 ns	Serial	RJ-8, RM-8	10 MHz Bandwidth, 50 MHz Serial

\*Future parts, contact factory for availability

# AD5426/AD5432/AD5443

## OUTLINE DIMENSIONS

### 10-Lead Mini Small Outline Package [MSOP] (RM-10)

Dimensions shown in millimeters

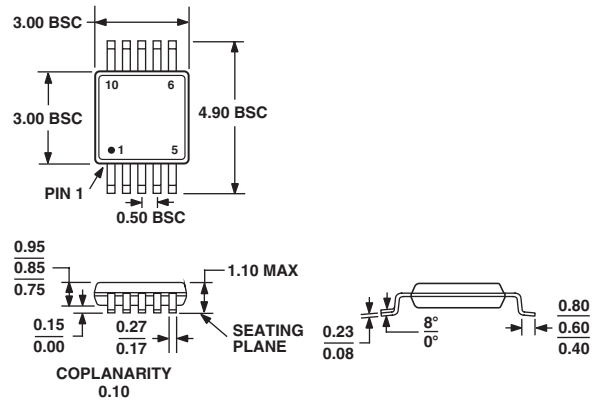

COMPLIANT TO JEDEC STANDARDS MO-187BA



