

# NE5532, SA5532, SE5532, NE5532A, SE5532A

## Internally Compensated Dual Low Noise Operational Amplifier

The 5532 is a dual high-performance low noise operational amplifier. Compared to most of the standard operational amplifiers, such as the 1458, it shows better noise performance, improved output drive capability and considerably higher small-signal and power bandwidths.

This makes the device especially suitable for application in high-quality and professional audio equipment, instrumentation and control circuits, and telephone channel amplifiers. The op amp is internally compensated for gains equal to one. If very low noise is of prime importance, it is recommended that the 5532A version be used because it has guaranteed noise voltage specifications.

### Features

- Small-Signal Bandwidth: 10 MHz
- Output Drive Capability: 600  $\Omega$ , 10 V<sub>RMS</sub>
- Input Noise Voltage: 5.0 nV/ $\sqrt{\text{Hz}}$  (Typical)
- DC Voltage Gain: 50000
- AC Voltage Gain: 2200 at 10 kHz
- Power Bandwidth: 140 kHz
- Slew Rate: 9.0 V/ $\mu\text{s}$
- Large Supply Voltage Range:  $\pm 3.0$  to  $\pm 20$  V
- Compensated for Unity Gain
- Pb-Free Packages are Available



**ON Semiconductor®**

<http://onsemi.com>



**SOIC-8  
D SUFFIX  
CASE 751**

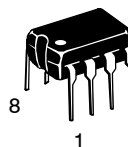

**PDIP-8  
N SUFFIX  
CASE 626**

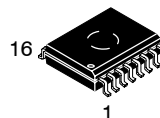

**SOIC-16 WB  
D SUFFIX  
CASE 751G**

### PIN CONNECTIONS

#### N, D8 Packages

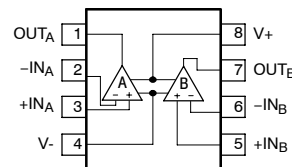

Top View

#### D Package\*

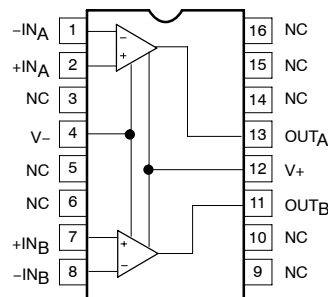

Top View

\*SOL and non-standard pinout.

### DEVICE MARKING INFORMATION

See general marking information in the device marking section on page 6 of this data sheet.

### ORDERING INFORMATION

See detailed ordering and shipping information in the package dimensions section on page 7 of this data sheet.

# NE5532, SA5532, SE5532, NE5532A, SE5532A

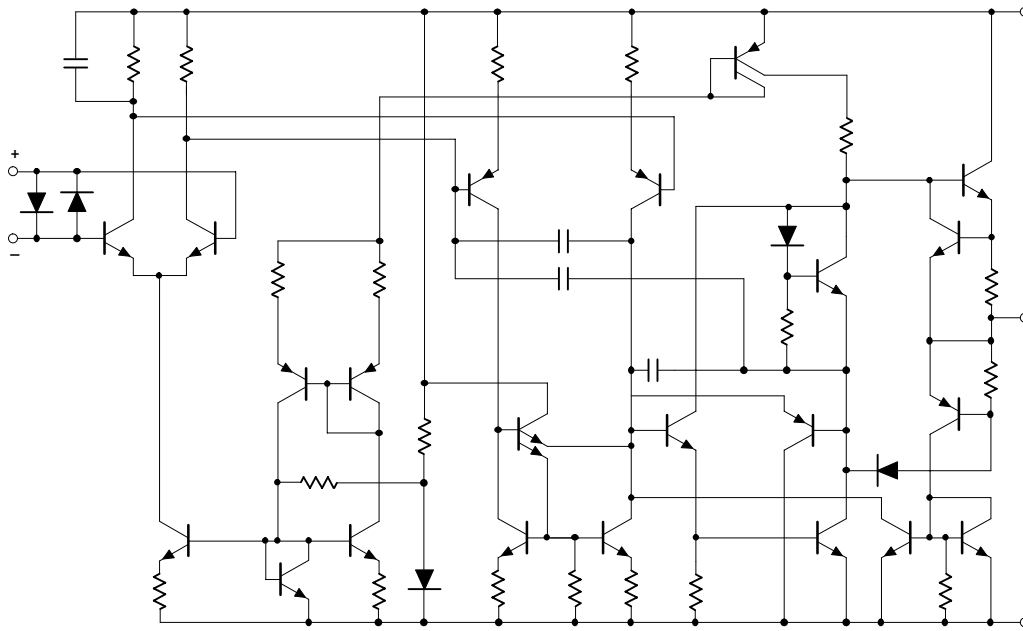

Figure 1. Equivalent Schematic (Each Amplifier)

## MAXIMUM RATINGS

Rating	Symbol	Value	Unit
Supply Voltage	$V_S$	$\pm 22$	V
Input Voltage	$V_{IN}$	$\pm V_{SUPPLY}$	V
Differential Input Voltage (Note 1)	$V_{DIFF}$	$\pm 0.5$	V
Operating Temperature Range NE5532/A SA5532 SE5532/A	$T_{amb}$	0 to 70 -40 to +85 -55 to +125	$^{\circ}C$
Storage Temperature	$T_{stg}$	-65 to +150	$^{\circ}C$
Junction Temperature	$T_j$	150	$^{\circ}C$
Maximum Power Dissipation, $T_{amb} = 25^{\circ}C$ (Still-Air) 8 D8 Package 8 N Package 16 D Package	$P_D$	780 1200 1200	mW
Thermal Resistance, Junction-to-Ambient 8 D8 Package 8 N Package 16 D Package	$R_{\theta JA}$	182 130 140	$^{\circ}C/W$
Lead Soldering Temperature (10 sec max)	$T_{sld}$	230	$^{\circ}C$

Stresses exceeding Maximum Ratings may damage the device. Maximum Ratings are stress ratings only. Functional operation above the Recommended Operating Conditions is not implied. Extended exposure to stresses above the Recommended Operating Conditions may affect device reliability.

- Diodes protect the inputs against overvoltage. Therefore, unless current-limiting resistors are used, large currents will flow if the differential input voltage exceeds 0.6 V. Maximum current should be limited to  $\pm 10$  mA.

# NE5532, SA5532, SE5532, NE5532A, SE5532A

## DC ELECTRICAL CHARACTERISTICS ( $T_{amb} = 25^{\circ}\text{C}$ ; $V_S = \pm 15\text{ V}$ , unless otherwise noted.) (Notes 2, 3 and 4)

Characteristic	Symbol	Test Conditions	SE5532/A			NE5532/A, SA5532			Unit
			Min	Typ	Max	Min	Typ	Max	
Offset Voltage	$V_{OS}$	-	-	0.5	2.0	-	0.5	4.0	mV
	-	Overtemperature	-	-	3.0	-	-	5.0	mV
	$\Delta V_{OS}/\Delta T$	-	-	5.0	-	-	5.0	-	$\mu\text{V}/^{\circ}\text{C}$
Offset Current	$I_{OS}$	-	-	-	100	-	10	150	nA
	-	Overtemperature	-	-	200	-	-	200	nA
	$\Delta I_{OS}/\Delta T$	-	-	200	-	-	200	-	$\text{pA}/^{\circ}\text{C}$
Input Current	$I_B$	-	-	200	400	-	200	800	nA
	-	Overtemperature	-	-	700	-	-	1000	nA
	$\Delta I_B/\Delta T$	-	-	5.0	-	-	5.0	-	$\text{nA}/^{\circ}\text{C}$
Supply Current	$I_{CC}$	-	-	8.0	10.5	-	8.0	16	mA
	-	Overtemperature	-	-	13	-	-	-	
Common-Mode Input Range	$V_{CM}$	-	$\pm 12$	$\pm 13$	-	$\pm 12$	$\pm 13$	-	V
Common-Mode Rejection Ratio	CMRR	-	80	100	-	70	100	-	dB
Power Supply Rejection Ratio	PSRR	-	-	10	50	-	10	100	$\mu\text{V}/\text{V}$
Large-Signal Voltage Gain	$A_{VOL}$	$R_L \geq 2.0\text{ k}\Omega$ ; $V_O = \pm 10\text{ V}$	50	100	-	25	100	-	V/mV
		Overtemperature	25	-	-	15	-	-	
		$R_L \geq 600\ \Omega$ ; $V_O = \pm 10\text{ V}$	40	50	-	15	50	-	
		Overtemperature	20	-	-	10	-	-	
Output Swing	$V_{OUT}$	$R_L \geq 600\ \Omega$	$\pm 12$	$\pm 13$	-	$\pm 12$	$\pm 13$	-	V
		Overtemperature	$\pm 10$	$\pm 12$	-	$\pm 10$	$\pm 12$	-	
		$R_L \geq 600\ \Omega$ ; $V_S = \pm 18\text{ V}$	$\pm 15$	$\pm 16$	-	$\pm 15$	$\pm 16$	-	
		Overtemperature	$\pm 12$	$\pm 14$	-	$\pm 12$	$\pm 14$	-	
		$R_L \geq 2.0\text{ k}\Omega$	$\pm 13$	$\pm 13.5$	-	$\pm 13$	$\pm 13.5$	-	
Overtemperature	$\pm 12$	$\pm 12.5$	-	$\pm 10$	$\pm 12.5$	-			
Input Resistance	$R_{IN}$	-	30	300	-	30	300	-	$\text{k}\Omega$
Output Short Circuit Current	$I_{SC}$	-	10	38	60	10	38	60	mA

2. Diodes protect the inputs against overvoltage. Therefore, unless current-limiting resistors are used, large currents will flow if the differential input voltage exceeds 0.6 V. Maximum current should be limited to  $\pm 10\text{ mA}$ .
3. For operation at elevated temperature, derate packages based on the package thermal resistance.
4. Output may be shorted to ground at  $V_S = \pm 15\text{ V}$ ,  $T_{amb} = 25^{\circ}\text{C}$ . Temperature and/or supply voltages must be limited to ensure dissipation rating is not exceeded.

# NE5532, SA5532, SE5532, NE5532A, SE5532A

## AC ELECTRICAL CHARACTERISTICS ( $T_{amb} = 25^{\circ}\text{C}$ ; $V_S = \pm 15\text{ V}$ , unless otherwise noted.)

Characteristic	Symbol	Test Conditions	NE/SE5532/A, SA5532			Unit
			Min	Typ	Max	
Output Resistance	$R_{OUT}$	$A_V = 30\text{ dB}$ Closed-loop $f = 10\text{ kHz}$ , $R_L = 600\ \Omega$	–	0.3	–	$\Omega$
Overshoot	–	Voltage-Follower $V_{IN} = 100\text{ mV}_{P-P}$ $C_L = 100\text{ pF}$ ; $R_L = 600\ \Omega$	–	10	–	%
Gain	$A_V$	$f = 10\text{ kHz}$	–	2.2	–	V/mV
Gain Bandwidth Product	GBW	$C_L = 100\text{ pF}$ ; $R_L = 600\ \Omega$	–	10	–	MHz
Slew Rate	SR	–	–	9.0	–	V/ $\mu\text{s}$
Power Bandwidth	–	$V_{OUT} = \pm 10\text{ V}$ $V_{OUT} = \pm 14\text{ V}$ ; $R_L = 600\ \Omega$  $V_{CC} = \pm 18\text{ V}$	–	140 100	–	kHz

## ELECTRICAL CHARACTERISTICS ( $T_{amb} = 25^{\circ}\text{C}$ ; $V_S = \pm 15\text{ V}$ , unless otherwise noted.)

Characteristic	Symbol	Test Conditions	NE/SE5532			NE/SA/SE5532A			Unit
			Min	Typ	Max	Min	Typ	Max	
Input Noise Voltage	$V_{NOISE}$	$f_O = 30\text{ Hz}$	–	8.0	–	–	8.0	12	nV/ $\sqrt{\text{Hz}}$
		$f_O = 1.0\text{ kHz}$	–	5.0	–	–	5.0	6.0	
Input Noise Current	$I_{NOISE}$	$f_O = 30\text{ Hz}$	–	2.7	–	–	2.7	–	pA/ $\sqrt{\text{Hz}}$
		$f_O = 1.0\text{ kHz}$	–	0.7	–	–	0.7	–	
Channel Separation	–	$f = 1.0\text{ kHz}$ ; $R_S = 5.0\text{ k}\Omega$	–	110	–	–	110	–	dB

TYPICAL PERFORMANCE CHARACTERISTICS

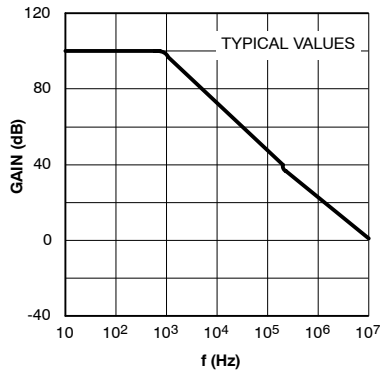

Figure 2. Open-Loop Frequency Response

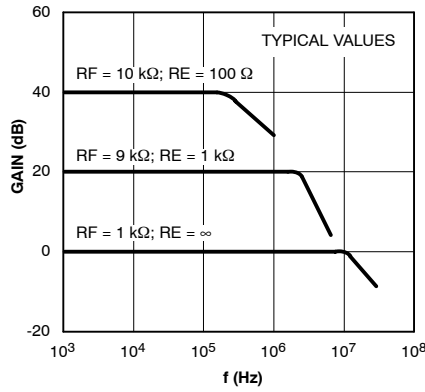

Figure 3. Closed-Loop Frequency Response

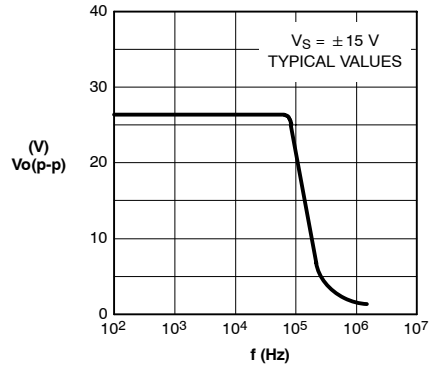

Figure 4. Large-Signal Frequency Response

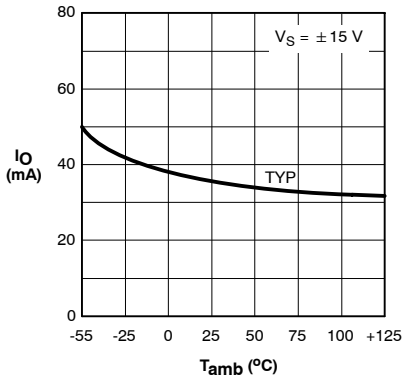

Figure 5. Output Short-Circuit Current

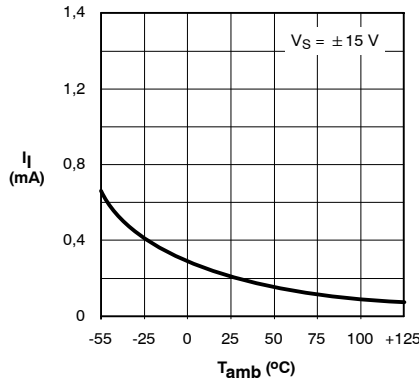

Figure 6. Input Bias Current

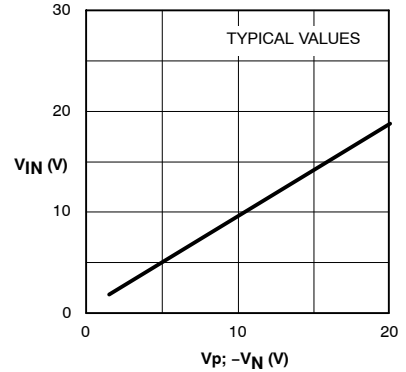

Figure 7. Input Common-Mode Voltage Range

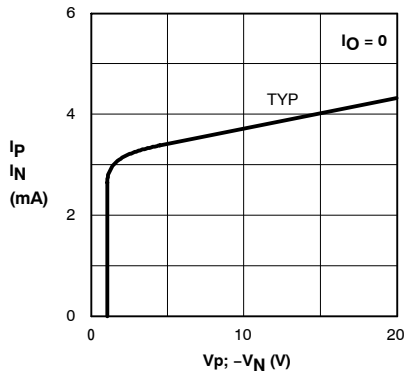

Figure 8. Supply Current

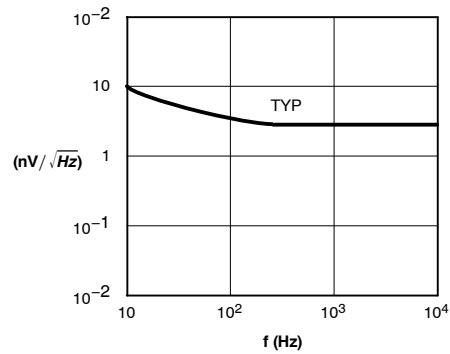
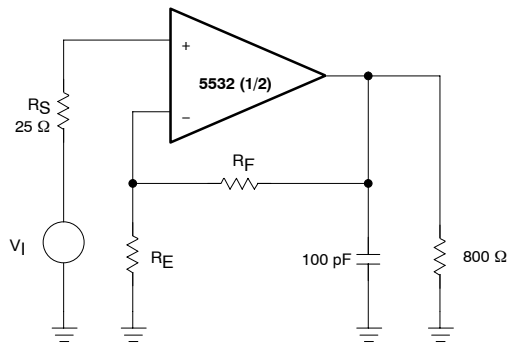
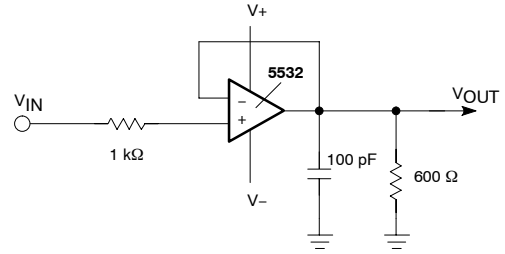

Figure 9. Input Noise Voltage Density

# NE5532, SA5532, SE5532, NE5532A, SE5532A



**Closed-Loop Frequency Response**



**Voltage-Follower**

**Figure 10. Test Circuits**

## MARKING DIAGRAMS

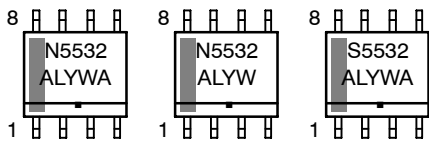

**SOIC-8  
D SUFFIX  
CASE 751**

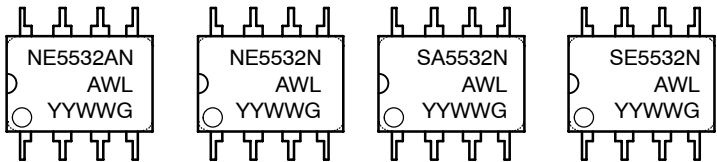

**PDIP-8  
N SUFFIX  
CASE 626**

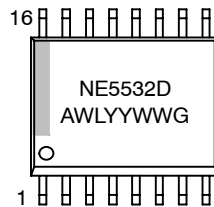

**SOIC-16 WB  
D SUFFIX  
CASE 751G**

- A = Assembly Location
- WL, L = Wafer Lot
- YY, Y = Year
- WW, W = Work Week
- G or ■ = Pb-Free Package

## NE5532, SA5532, SE5532, NE5532A, SE5532A

### ORDERING INFORMATION

Device	Description	Temperature Range	Shipping†
NE5532AD8	8-Pin Plastic Small Outline (SO-8) Package	0 to 70°C	98 Units / Rail
NE5532AD8G	8-Pin Plastic Small Outline (SO-8) Package (Pb-Free)	0 to 70°C	98 Units / Rail
NE5532AD8R2	8-Pin Plastic Small Outline (SO-8) Package	0 to 70°C	2500 / Tape & Reel
NE5532AD8R2G	8-Pin Plastic Small Outline (SO-8) Package (Pb-Free)	0 to 70°C	2500 / Tape & Reel
NE5532AN	8-Pin Plastic Dual In-Line Package (PDIP-8)	0 to 70°C	50 Units / Rail
NE5532ANG	8-Pin Plastic Dual In-Line Package (PDIP-8) (Pb-Free)	0 to 70°C	50 Units / Rail
NE5532D	16-Pin Plastic Small Outline (SO-16 WB) Package	0 to 70°C	47 Units / Rail
NE5532DG	16-Pin Plastic Small Outline (SO-16 WB) Package (Pb-Free)	0 to 70°C	47 Units / Rail
NE5532DR2	16-Pin Plastic Small Outline (SO-16 WB) Package	0 to 70°C	1000 Tape & Reel
NE5532DR2G	16-Pin Plastic Small Outline (SO-16 WB) Package (Pb-Free)	0 to 70°C	1000 Tape & Reel
NE5532D8	8-Pin Plastic Small Outline (SO-8) Package	0 to 70°C	98 Units / Rail
NE5532D8G	8-Pin Plastic Small Outline (SO-8) Package (Pb-Free)	0 to 70°C	98 Units / Rail
NE5532D8R2	8-Pin Plastic Small Outline (SO-8) Package	0 to 70°C	2500 / Tape & Reel
NE5532D8R2G	8-Pin Plastic Small Outline (SO-8) Package (Pb-Free)	0 to 70°C	2500 / Tape & Reel
NE5532N	8-Pin Plastic Dual In-Line Package (PDIP-8)	0 to 70°C	50 Units / Rail
NE5532NG	8-Pin Plastic Dual In-Line Package (PDIP-8) (Pb-Free)	0 to 70°C	50 Units / Rail
SA5532N	8-Pin Plastic Dual In-Line Package (PDIP-8)	-40 to +85°C	50 Units / Rail
SA5532NG	8-Pin Plastic Dual In-Line Package (PDIP-8) (Pb-Free)	-40 to +85°C	50 Units / Rail
SE5532AD8	8-Pin Plastic Small Outline (SO-8) Package	-55 to +125°C	98 Units / Rail
SE5532AD8G	8-Pin Plastic Small Outline (SO-8) Package (Pb-Free)	-55 to +125°C	98 Units / Rail
SE5532AD8R2	8-Pin Plastic Small Outline (SO-8) Package	-55 to +125°C	2500 / Tape & Reel
SE5532AD8R2G	8-Pin Plastic Small Outline (SO-8) Package (Pb-Free)	-55 to +125°C	2500 / Tape & Reel
SE5532N	8-Pin Plastic Dual In-Line Package (PDIP-8)	-55 to +125°C	50 Units / Rail
SE5532NG	8-Pin Plastic Dual In-Line Package (PDIP-8) (Pb-Free)	-55 to +125°C	50 Units / Rail

†For information on tape and reel specifications, including part orientation and tape sizes, please refer to our Tape and Reel Packaging Specifications Brochure, BRD8011/D.

# NE5532, SA5532, SE5532, NE5532A, SE5532A

## PACKAGE DIMENSIONS

SOIC-8 NB  
CASE 751-07  
ISSUE AG

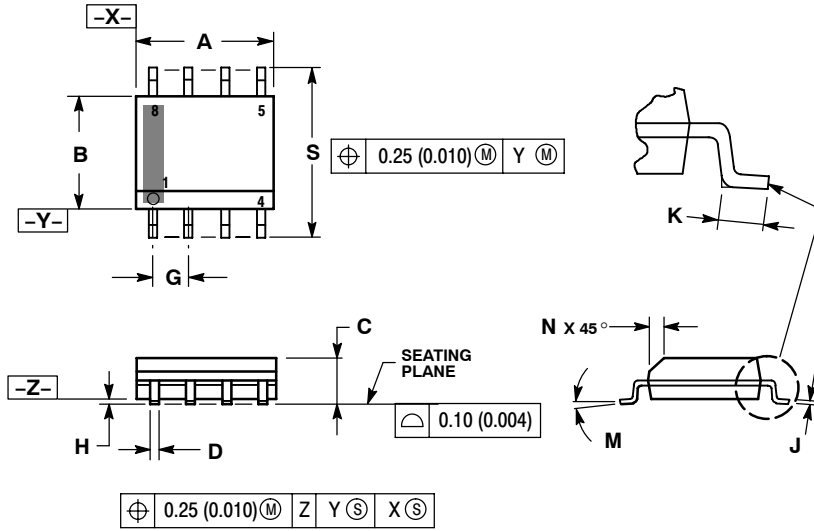

### NOTES:

1. DIMENSIONING AND TOLERANCING PER ANSI Y14.5M, 1982.
2. CONTROLLING DIMENSION: MILLIMETER.
3. DIMENSION A AND B DO NOT INCLUDE MOLD PROTRUSION.
4. MAXIMUM MOLD PROTRUSION 0.15 (0.006) PER SIDE.
5. DIMENSION D DOES NOT INCLUDE DAMBAR PROTRUSION. ALLOWABLE DAMBAR PROTRUSION SHALL BE 0.127 (0.005) TOTAL IN EXCESS OF THE D DIMENSION AT MAXIMUM MATERIAL CONDITION.
6. 751-01 THRU 751-06 ARE OBSOLETE. NEW STANDARD IS 751-07.

DIM	MILLIMETERS		INCHES	
	MIN	MAX	MIN	MAX
A	4.80	5.00	0.189	0.197
B	3.80	4.00	0.150	0.157
C	1.35	1.75	0.053	0.069
D	0.33	0.51	0.013	0.020
G	1.27 BSC		0.050 BSC	
H	0.10	0.25	0.004	0.010
J	0.19	0.25	0.007	0.010
K	0.40	1.27	0.016	0.050
M	0°	8°	0°	8°
N	0.25	0.50	0.010	0.020
S	5.80	6.20	0.228	0.244

### SOLDERING FOOTPRINT\*

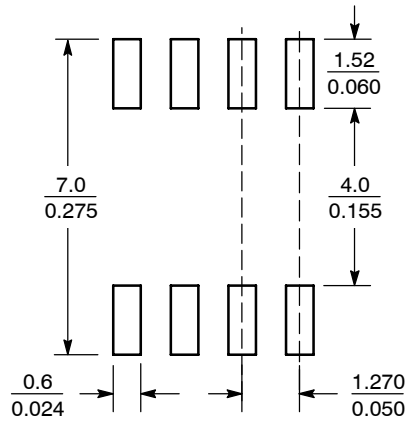

SCALE 6:1  $\left(\frac{\text{mm}}{\text{inches}}\right)$

\*For additional information on our Pb-Free strategy and soldering details, please download the ON Semiconductor Soldering and Mounting Techniques Reference Manual, SOLDERRM/D.



# NE5532, SA5532, SE5532, NE5532A, SE5532A

## PACKAGE DIMENSIONS

### 8-Pin Plastic Dual In-Line Package (PDIP-8)

N SUFFIX  
CASE 626-05  
ISSUE L

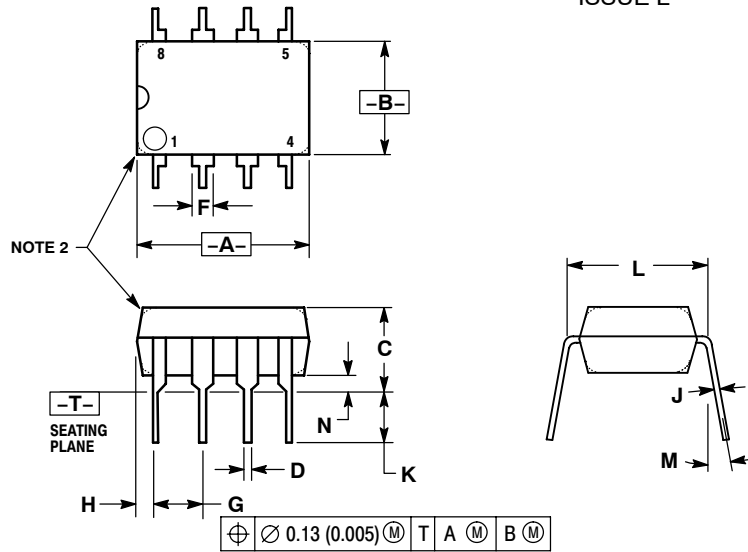

#### NOTES:

1. DIMENSION L TO CENTER OF LEAD WHEN FORMED PARALLEL.
2. PACKAGE CONTOUR OPTIONAL (ROUND OR SQUARE CORNERS).
3. DIMENSIONING AND TOLERANCING PER ANSI Y14.5M, 1982.

DIM	MILLIMETERS		INCHES	
	MIN	MAX	MIN	MAX
A	9.40	10.16	0.370	0.400
B	6.10	6.60	0.240	0.260
C	3.94	4.45	0.155	0.175
D	0.38	0.51	0.015	0.020
F	1.02	1.78	0.040	0.070
G	2.54 BSC		0.100 BSC	
H	0.76	1.27	0.030	0.050
J	0.20	0.30	0.008	0.012
K	2.92	3.43	0.115	0.135
L	7.62 BSC		0.300 BSC	
M	---	10°	---	10°
N	0.76	1.01	0.030	0.040

# NE5532, SA5532, SE5532, NE5532A, SE5532A

## PACKAGE DIMENSIONS

SOIC-16 WB  
D SUFFIX  
CASE 751G-03  
ISSUE C

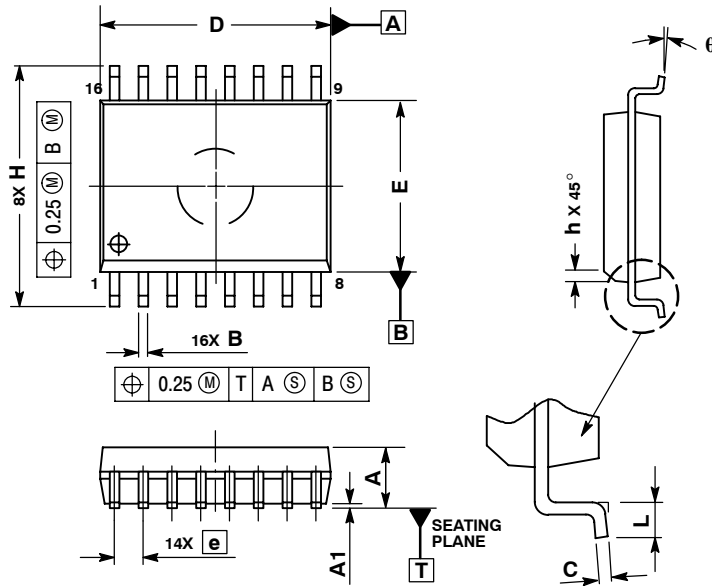

### NOTES:

1. DIMENSIONS ARE IN MILLIMETERS.
2. INTERPRET DIMENSIONS AND TOLERANCES PER ASME Y14.5M, 1994.
3. DIMENSIONS D AND E DO NOT INCLUDE MOLD PROTRUSION.
4. MAXIMUM MOLD PROTRUSION 0.15 PER SIDE.
5. DIMENSION B DOES NOT INCLUDE DAMBAR PROTRUSION. ALLOWABLE DAMBAR PROTRUSION SHALL BE 0.13 TOTAL IN EXCESS OF THE B DIMENSION AT MAXIMUM MATERIAL CONDITION.

DIM	MILLIMETERS	
	MIN	MAX
A	2.35	2.65
A1	0.10	0.25
B	0.35	0.49
C	0.23	0.32
D	10.15	10.45
E	7.40	7.60
e	1.27	BSC
H	10.05	10.55
h	0.25	0.75
L	0.50	0.90
q	0°	7°

ON Semiconductor and are registered trademarks of Semiconductor Components Industries, LLC (SCILLC). SCILLC reserves the right to make changes without further notice to any products herein. SCILLC makes no warranty, representation or guarantee regarding the suitability of its products for any particular purpose, nor does SCILLC assume any liability arising out of the application or use of any product or circuit, and specifically disclaims any and all liability, including without limitation special, consequential or incidental damages. "Typical" parameters which may be provided in SCILLC data sheets and/or specifications can and do vary in different applications and actual performance may vary over time. All operating parameters, including "Typicals" must be validated for each customer application by customer's technical experts. SCILLC does not convey any license under its patent rights nor the rights of others. SCILLC products are not designed, intended, or authorized for use as components in systems intended for surgical implant into the body, or other applications intended to support or sustain life, or for any other application in which the failure of the SCILLC product could create a situation where personal injury or death may occur. Should Buyer purchase or use SCILLC products for any such unintended or unauthorized application, Buyer shall indemnify and hold SCILLC and its officers, employees, subsidiaries, affiliates, and distributors harmless against all claims, costs, damages, and expenses, and reasonable attorney fees arising out of, directly or indirectly, any claim of personal injury or death associated with such unintended or unauthorized use, even if such claim alleges that SCILLC was negligent regarding the design or manufacture of the part. SCILLC is an Equal Opportunity/Affirmative Action Employer. This literature is subject to all applicable copyright laws and is not for resale in any manner.

### PUBLICATION ORDERING INFORMATION

#### LITERATURE FULFILLMENT:

Literature Distribution Center for ON Semiconductor  
P.O. Box 61312, Phoenix, Arizona 85082-1312 USA  
Phone: 480-829-7710 or 800-344-3860 Toll Free USA/Canada  
Fax: 480-829-7709 or 800-344-3867 Toll Free USA/Canada  
Email: [orderlit@onsemi.com](mailto:orderlit@onsemi.com)

N. American Technical Support: 800-282-9855 Toll Free  
USA/Canada

Japan: ON Semiconductor, Japan Customer Focus Center  
2-9-1 Kamimeguro, Meguro-ku, Tokyo, Japan 153-0051  
Phone: 81-3-5773-3850

ON Semiconductor Website: <http://onsemi.com>

Order Literature: <http://www.onsemi.com/litorder>

For additional information, please contact your  
local Sales Representative.