

Precision High-Voltage Reference in SOT23

General Description

The MAX6043 precision voltage reference provides accurate preset +2.5V, +3.3V, +4.096V, +5.0V, and +10V reference voltages from up to +40V input voltages. The MAX6043 features a proprietary temperature coefficient curvature-correction circuit and laser-trimmed thin-film resistors that result in a very low temperature coefficient of 15ppm/°C (max) and excellent initial accuracy of 0.05% (max). Low temperature drift and low noise make the MAX6043 ideal for use with high-resolution A/D or D/A converters.

The MAX6043 draws 320μA of supply current and sources 10mA or sinks 0.6mA of load current. The MAX6043 uses bandgap technology for low-noise performance and excellent accuracy. The MAX6043 does not require an output bypass capacitor for stability, and is stable with capacitive loads up to 100μF. Eliminating the output bypass capacitor saves valuable board area in space-critical applications. The supply-independent, low supply current makes the MAX6043 ideal for battery-operated, high-performance systems.

The MAX6043 is available in a 6-pin SOT23 package and operates over the automotive (-40°C to +125°C) temperature range.

Applications

Analog-to-Digital Converters
 Digital-to-Analog Converters
 Digital Voltmeters
 Voltage Regulators
 Threshold Detectors

Pin Configuration

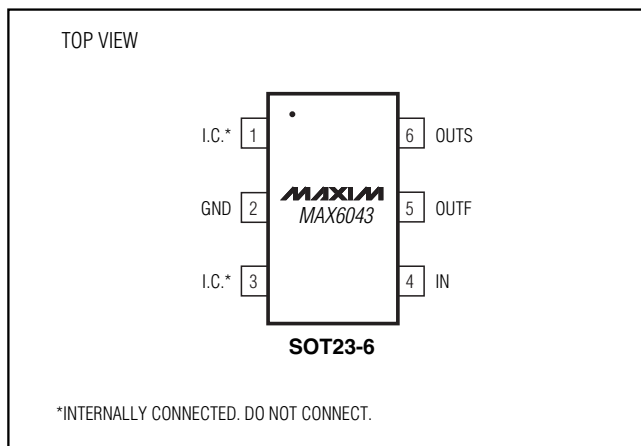

Features

- ◆ +2.5V, +3.3V, +4.096V, +5.0V, or +10V Output Voltages
- ◆ Excellent Temperature Stability: 15ppm/°C (max)
- ◆ Tight Initial Accuracy: 0.05% (max)
- ◆ Tiny SOT23 Package
- ◆ Wide +4.5V to +40V Supply Voltage Range
- ◆ Low Noise: 4μVp-p (typ at 2.5V Output)
- ◆ Short-Circuit Protected
- ◆ Wide Operating Temperature Range
-40°C to +125°C
- ◆ Stable with Capacitive Loads from 0 to 100μF
- ◆ No External Capacitors Required for Stability

Ordering Information

PART	TEMP RANGE	PIN-PACKAGE	TOP MARK
MAX6043AAUT25-T	-40°C to +125°C	6 SOT23-6	ABRZ
MAX6043BAUT25-T	-40°C to +125°C	6 SOT23-6	ABDQ
MAX6043CAUT25-T	-40°C to +125°C	6 SOT23-6	ABDR

Ordering Information continued at end of data sheet.

Typical Operating Circuit appears at end of data sheet.

Selector Guide

PART	OUTPUT VOLTAGE (V)	TEMPCO (ppm/°C) -40°C to +125°C	INITIAL ACCURACY (%)
MAX6043AAUT25	2.5	15	0.06
MAX6043BAUT25	2.5	20	0.1
MAX6043CAUT25	2.5	65	0.5
MAX6043AAUT33	3.3	15	0.06
MAX6043BAUT33	3.3	20	0.1
MAX6043CAUT33	3.3	65	0.5
MAX6043AAUT41	4.096	15	0.06
MAX6043BAUT41	4.096	20	0.1
MAX6043CAUT41	4.096	65	0.5
MAX6043AAUT50	5.0	15	0.06
MAX6043BAUT50	5.0	20	0.1
MAX6043CAUT50	5.0	65	0.5
MAX6043AAUT10	10.0	15	0.05
MAX6043BAUT10	10.0	20	0.1
MAX6043CAUT10	10.0	65	0.5

Precision High-Voltage Reference in SOT23

ABSOLUTE MAXIMUM RATINGS

IN to GND-0.3V to +42V
 OUF, OUS to GND-0.3V to (V_{IN} + 0.3V)
 Continuous Power Dissipation (T_A = +70°C)
 6-Pin SOT23 (derate 9.1mW/°C above +70°C).....727mW
 OUT_ Short-Circuit Duration5s

Operating Temperature Range-40°C to +125°C
 Storage Temperature Range-65°C to +150°C
 Junction Temperature Range-65°C to +150°C
 Lead Temperature (soldering, 10s)+300°C

Stresses beyond those listed under "Absolute Maximum Ratings" may cause permanent damage to the device. These are stress ratings only, and functional operation of the device at these or any other conditions beyond those indicated in the operational sections of the specifications is not implied. Exposure to absolute maximum rating conditions for extended periods may affect device reliability.

ELECTRICAL CHARACTERISTICS—V_{OUT} = +2.5V

(V_{IN} = +5V, I_{OUT} = 0, T_A = T_{MIN} to T_{MAX}. Typical values are at T_A = +25°C, unless otherwise noted.) (Note 1)

PARAMETER	CONDITIONS		MIN	TYP	MAX	UNITS
OUTPUT						
Output Voltage	I _{OUT} = 0, T _A = +25°C	MAX6043A (0.06%)	2.4985	2.5000	2.5015	V
		MAX6043B (0.1%)	2.4975	2.5000	2.5025	
		MAX6043C (0.5%)	2.4876	2.5000	2.5125	
Output-Voltage Temperature Coefficient (Note 2)	T _A = -40°C to +125°C	MAX6043A_25		3	15	ppm/°C
		MAX6043B_25		5	25	
		MAX6043C_25		10	65	
Line Regulation (Note 4)	4.5V < V _{IN} < 40V	T _A = +25°C		1	6	ppm/V
		T _A = -40°C to +125°C		1.5	10	
Load Regulation (Note 4)	Sourcing, 0 < I _{OUT} < 10mA	T _A = +25°C		8	70	ppm/mA
		T _A = -40°C to +125°C			70	
	Sinking, -0.6mA < I _{OUT} < 0mA	T _A = +25°C		70	900	
		T _A = -40°C to +125°C			900	
OUT Short-Circuit Current	Output shorted to GND			60		mA
	Output shorted to IN			-2		
Thermal Hysteresis	(Note 3)			150		ppm
Long-Term Stability	Δt = 1000hr			150		ppm
DYNAMIC CHARACTERISTICS						
Output Noise Voltage	0.1Hz to 10Hz			4		μV _{P-P}
	10Hz to 1kHz			7		μV _{RMS}
Turn-On Settling Time	To V _{OUT} = 0.05% of final value, C _{OUT} = 50pF			150		μs
INPUT						
Supply Voltage Range	Inferred from line regulation test		4.5		40.0	V
Quiescent Supply Current	I _{OUT} = 0	T _A = +25°C		320	490	μA
		T _A = -40°C to +125°C		370	650	

Precision High-Voltage Reference in SOT23

MAX6043

ELECTRICAL CHARACTERISTICS— $V_{OUT} = +3.3V$

($V_{IN} = +10V$, $I_{OUT} = 0$, $T_A = T_{MIN}$ to T_{MAX} . Typical values are at $T_A = +25^\circ C$, unless otherwise noted.) (Note 1)

PARAMETER	CONDITIONS	MIN	TYP	MAX	UNITS	
OUTPUT						
Output Voltage	$I_{OUT} = 0$, $T_A = +25^\circ C$	MAX6043A (0.06%)	3.2980	3.3000	3.3020	V
		MAX6043B (0.1%)	3.2967	3.3000	3.3033	
		MAX6043C (0.5%)	3.2836	3.3000	3.3165	
Output-Voltage Temperature Coefficient (Note 2)	$T_A = -40^\circ C$ to $+125^\circ C$	MAX6043A_33		3	15	ppm/ $^\circ C$
		MAX6043B_33		5	25	
		MAX6043C_33		10	65	
Line Regulation (Note 4)	$5.3V \leq V_{IN} \leq 40V$	$T_A = +25^\circ C$		1	6	ppm/V
		$T_A = -40^\circ C$ to $+125^\circ C$		1.5	10	
Load Regulation (Note 4)	Sourcing, $0 \leq I_{OUT} \leq 10mA$	$T_A = +25^\circ C$		23	70	ppm/mA
		$T_A = -40^\circ C$ to $+125^\circ C$			70	
	Sinking, $-0.6mA \leq I_{OUT} \leq 0mA$	$T_A = +25^\circ C$		100	900	
		$T_A = -40^\circ C$ to $+125^\circ C$			900	
OUT Short-Circuit Current	OUT shorted to GND		60		mA	
	OUT shorted to IN		-2			
Thermal Hysteresis	(Note 3)		150		ppm	
Long-Term Stability	$\Delta t = 1000hr$		150		ppm	
DYNAMIC CHARACTERISTICS						
Output Noise Voltage	0.1Hz to 10Hz		5.3		μV_{P-P}	
	10Hz to 1kHz		9.5		μV_{RMS}	
Turn-On Settling Time	To $V_{OUT} = 0.05\%$ of final value, $C_{OUT} = 50pF$		180		μs	
INPUT						
Supply Voltage Range	Inferred from line regulation test	5.3		40.0	V	
Quiescent Supply Current	$I_{OUT} = 0$	$T_A = +25^\circ C$		320	490	μA
		$T_A = -40^\circ C$ to $+125^\circ C$		380	650	

Precision High-Voltage Reference in SOT23

ELECTRICAL CHARACTERISTICS— $V_{OUT} = +4.096V$

($V_{IN} = +10V$, $I_{OUT} = 0$, $T_A = T_{MIN}$ to T_{MAX} . Typical values are at $T_A = +25^\circ C$, unless otherwise noted.) (Note 1)

PARAMETER	CONDITIONS		MIN	TYP	MAX	UNITS
OUTPUT						
Output Voltage	$I_{OUT} = 0$, $T_A = +25^\circ C$	MAX6043A (0.06%)	4.0935	4.0960	4.0985	V
		MAX6043B (0.1%)	4.0919	4.0960	4.1001	
		MAX6043C (0.5%)	4.0755	4.0960	4.1165	
Output-Voltage Temperature Coefficient (Note 2)	$T_A = -40^\circ C$ to $+125^\circ C$	MAX6043A_41		3	15	ppm/ $^\circ C$
		MAX6043B_41		5	25	
		MAX6043C_41		10	65	
Line Regulation (Note 4)	$6.1V \leq V_{IN} \leq 40V$	$T_A = +25^\circ C$		1	6	ppm/V
		$T_A = -40^\circ C$ to $+125^\circ C$		1.5	10	
Load Regulation (Note 4)	Sourcing, $0 \leq I_{OUT} \leq 10mA$	$T_A = +25^\circ C$		19	70	ppm/mA
		$T_A = -40^\circ C$ to $+125^\circ C$			70	
	Sinking, $-0.6mA \leq I_{OUT} \leq 0mA$	$T_A = +25^\circ C$		100	900	
		$T_A = -40^\circ C$ to $+125^\circ C$			900	
OUT Short-Circuit Current	OUT shorted to GND			60		mA
	OUT shorted to IN			-2		
Thermal Hysteresis	(Note 3)			150		ppm
Long-Term Stability	$\Delta t = 1000hr$			150		ppm
DYNAMIC CHARACTERISTICS						
Output Noise Voltage	0.1Hz to 10Hz			6.6		μV_{P-P}
	10Hz to 1kHz			12		μV_{RMS}
Turn-On Settling Time	T_o to $V_{OUT} = 0.05\%$ of final value, $C_{OUT} = 50pF$			200		μs
INPUT						
Supply Voltage Range	Inferred from line regulation test		6.1		40.0	V
Quiescent Supply Current	$I_{OUT} = 0$	$T_A = +25^\circ C$		320	490	μA
		$T_A = -40^\circ C$ to $+125^\circ C$		380	650	

Precision High-Voltage Reference in SOT23

MAX6043

ELECTRICAL CHARACTERISTICS— $V_{OUT} = +5.0V$

($V_{IN} = +15V$, $I_{OUT} = 0$, $T_A = T_{MIN}$ to T_{MAX} . Typical values are at $T_A = +25^\circ C$, unless otherwise noted.) (Note 1)

PARAMETER	CONDITIONS	MIN	TYP	MAX	UNITS	
OUTPUT						
Output Voltage	$I_{OUT} = 0$, $T_A = +25^\circ C$	MAX6043A (0.06%)	4.9970	5.0000	5.0030	V
		MAX6043B (0.1%)	4.9950	5.0000	5.0050	
		MAX6043C (0.5%)	4.9751	5.0000	5.0250	
Output-Voltage Temperature Coefficient (Note 2)	$T_A = -40^\circ C$ to $+125^\circ C$	MAX6043A_50		3	15	ppm/ $^\circ C$
		MAX6043B_50		5	25	
		MAX6043C_50		10	65	
Line Regulation (Note 4)	$7V \leq V_{IN} \leq 40V$	$T_A = +25^\circ C$		1	6	ppm/V
		$T_A = -40^\circ C$ to $+125^\circ C$		1.5	10	
Load Regulation (Note 4)	Sourcing, $0 \leq I_{OUT} \leq 10mA$	$T_A = +25^\circ C$		32	70	ppm/mA
		$T_A = -40^\circ C$ to $+125^\circ C$			70	
	Sinking, $-0.6mA \leq I_{OUT} \leq 0mA$	$T_A = +25^\circ C$		130	900	
		$T_A = -40^\circ C$ to $+125^\circ C$			900	
OUT Short-Circuit Current	OUT shorted to GND		60		mA	
	OUT shorted to IN		-2			
Thermal Hysteresis	(Note 3)		150		ppm	
Long-Term Stability	$\Delta t = 1000hr$		150		ppm	
DYNAMIC CHARACTERISTICS						
Output Noise Voltage	0.1Hz to 10Hz		9.5		μV_{P-P}	
	10Hz to 1kHz		15		μV_{RMS}	
Turn-On Settling Time	To $V_{OUT} = 0.05\%$ of final value, $C_{OUT} = 50pF$		230		μs	
INPUT						
Supply Voltage Range	Inferred from line regulation test	7.0		40.0	V	
Quiescent Supply Current	$I_{OUT} = 0$	$T_A = +25^\circ C$		320	490	μA
		$T_A = -40^\circ C$ to $+125^\circ C$		380	650	

Precision High-Voltage Reference in SOT23

ELECTRICAL CHARACTERISTICS— $V_{OUT} = +10.0V$

($V_{IN} = +15V$, $I_{OUT} = 0$, $T_A = T_{MIN}$ to T_{MAX} . Typical values are at $T_A = +25^\circ C$, unless otherwise noted.) (Note 1)

PARAMETER	CONDITIONS	MIN	TYP	MAX	UNITS	
OUTPUT						
Output Voltage	$I_{OUT} = 0$, $T_A = +25^\circ C$	MAX6043A (0.05%)	9.9950	10.0000	10.0050	V
		MAX6043B (0.1%)	9.9900	10.0000	10.0100	
		MAX6043C (0.5%)	9.9500	10.0000	10.0500	
Output-Voltage Temperature Coefficient (Note 2)	$T_A = -40^\circ C$ to $+125^\circ C$	MAX6043A_10		3	15	ppm/ $^\circ C$
		MAX6043B_10		5	25	
		MAX6043C_10		10	65	
Line Regulation (Note 4)	$12V \leq V_{IN} \leq 40V$	$T_A = +25^\circ C$		1	6	ppm/V
		$T_A = -40^\circ C$ to $+125^\circ C$		1.5	10	
Load Regulation (Note 4)	Sourcing, $0 \leq I_{OUT} \leq 10mA$	$T_A = +25^\circ C$		16	70	ppm/mA
		$T_A = -40^\circ C$ to $+125^\circ C$			70	
	Sinking, $-0.6mA \leq I_{OUT} \leq 0mA$	$T_A = +25^\circ C$		170	900	
		$T_A = -40^\circ C$ to $+125^\circ C$			900	
OUT Short-Circuit Current	OUT shorted to GND		60		mA	
	OUT shorted to IN		-2			
Thermal Hysteresis	(Note 3)		150		ppm	
Long-Term Stability	$\Delta t = 1000hr$		150		ppm	
DYNAMIC CHARACTERISTICS						
Output Noise Voltage	0.1Hz to 10Hz		19		μV_{P-P}	
	10Hz to 1kHz		30		μV_{RMS}	
Turn-On Settling Time	To $V_{OUT} = 0.05\%$ of final value, $C_{OUT} = 50pF$		390		μs	
INPUT						
Supply Voltage Range	Inferred from line regulation test	12.0		40.0	V	
Quiescent Supply Current	$I_{OUT} = 0$	$T_A = +25^\circ C$		320	490	μA
		$T_A = -40^\circ C$ to $+125^\circ C$		390	650	

Note 1: All devices are 100% production tested at $T_A = +25^\circ C$ and guaranteed by design over $T_A = T_{MIN}$ to T_{MAX} as specified.

Note 2: Temperature coefficient is defined as ΔV_{OUT} divided by the temperature range.

Note 3: Thermal hysteresis defined as the change in output voltage at $T_A = +25^\circ C$ before and after cycling the device from T_{MAX} to T_{MIN} .

Note 4: Line and load regulation do not include the effect of self heating.

Precision High-Voltage Reference in SOT23

Typical Operating Characteristics

($V_{IN} = +5V$ for $V_{OUT} = +2.5V$, $V_{IN} = +10V$ for $V_{OUT} = +3.3V$ or $+4.096V$, $V_{IN} = +15V$ for $V_{OUT} = +5V$ or $+10V$, $I_{OUT} = 0$, $T_A = +25^\circ C$, unless otherwise noted.)

MAX6043

OUTPUT VOLTAGE vs. TEMPERATURE
($V_{OUT} = 2.5V$)

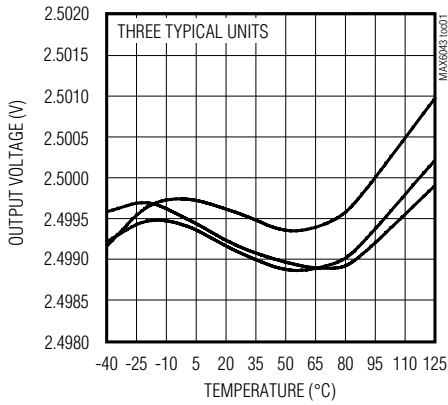

OUTPUT VOLTAGE vs. TEMPERATURE
($V_{OUT} = 10V$)

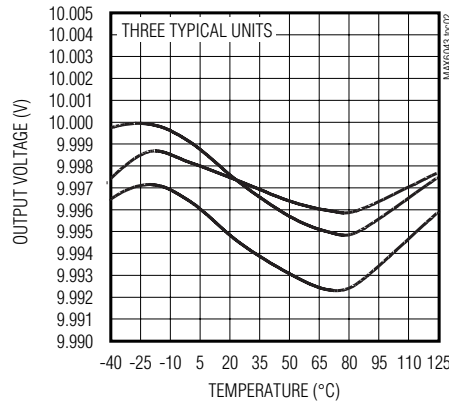

LOAD REGULATION
(SOURCING, $V_{OUT} = 10V$)

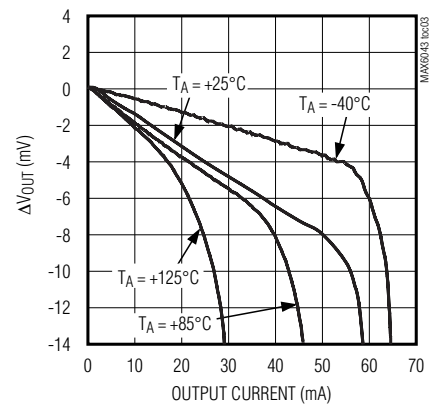

LOAD REGULATION
(SOURCING, $V_{OUT} = 2.5V$)

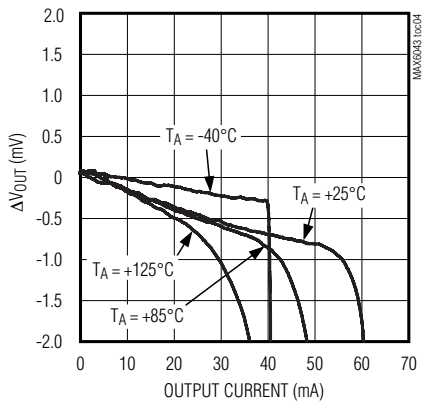

LOAD REGULATION
(SINKING, $V_{OUT} = 10V$)

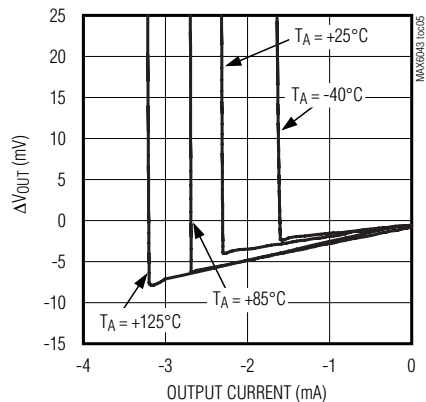

LOAD REGULATION
(SINKING, $V_{OUT} = 2.5V$)

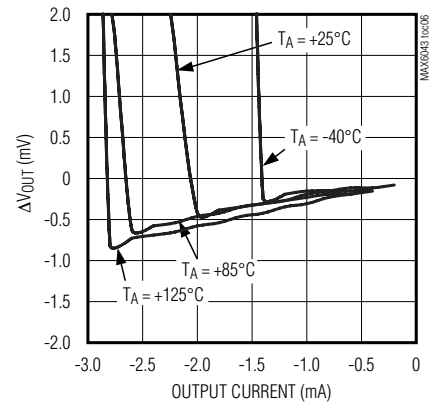

LINE REGULATION
($V_{OUT} = 2.5V$)

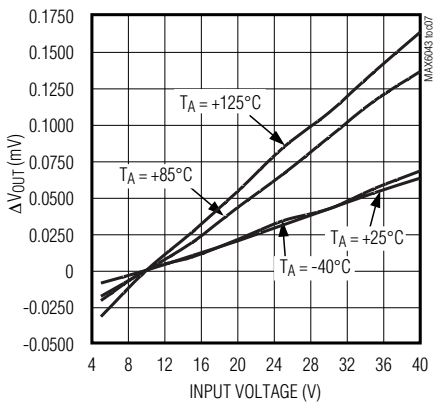

LINE REGULATION
($V_{OUT} = 10V$)

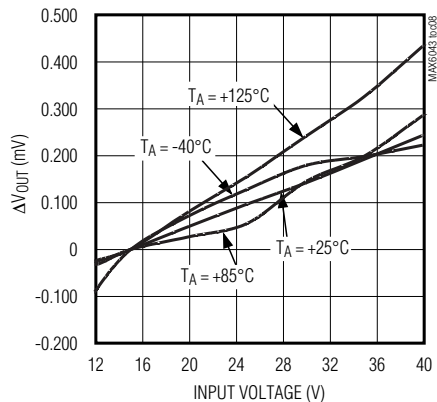

MINIMUM INPUT-OUTPUT DIFFERENTIAL
vs. LOAD CURRENT ($V_{OUT} = 2.5V$)

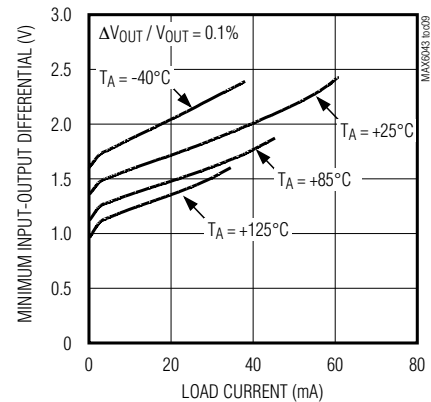

Precision High-Voltage Reference in SOT23

Typical Operating Characteristics (continued)

($V_{IN} = +5V$ for $V_{OUT} = +2.5V$, $V_{IN} = +10V$ for $V_{OUT} = +3.3V$ or $+4.096V$, $V_{IN} = +15V$ for $V_{OUT} = +5V$ or $+10V$, $I_{OUT} = 0$, $T_A = +25^\circ C$, unless otherwise noted.)

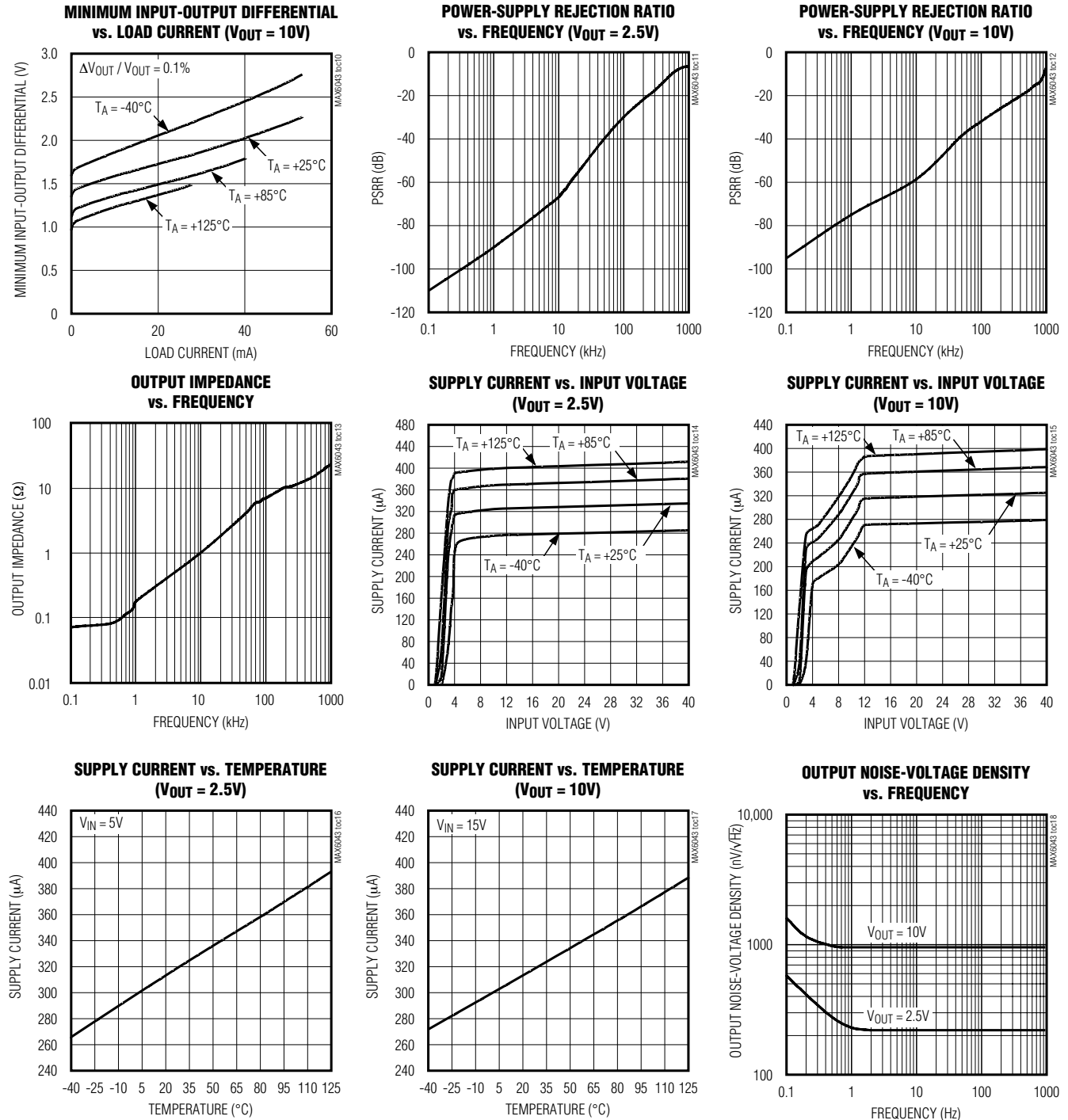

Precision High-Voltage Reference in SOT23

MAX6043

Typical Operating Characteristics (continued)

($V_{IN} = +5V$ for $V_{OUT} = +2.5V$, $V_{IN} = +10V$ for $V_{OUT} = +3.3V$ or $+4.096V$, $V_{IN} = +15V$ for $V_{OUT} = +5V$ or $+10V$, $I_{OUT} = 0$, $T_A = +25^\circ C$, unless otherwise noted.)

0.1Hz TO 10Hz OUTPUT NOISE
($V_{OUT} = 2.5V$)

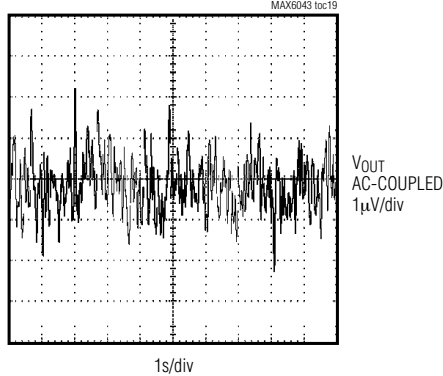

0.1Hz TO 10Hz OUTPUT NOISE
($V_{OUT} = 10V$)

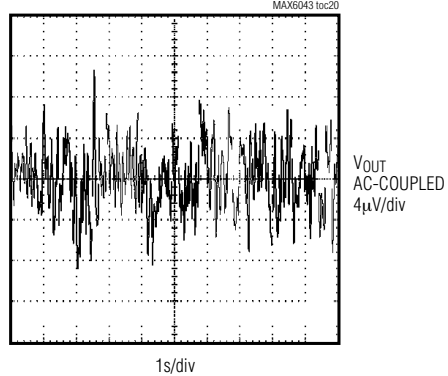

LOAD TRANSIENT
($V_{OUT} = 2.5V$)

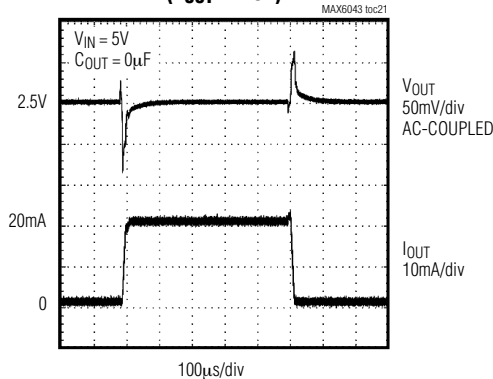

LOAD TRANSIENT
($V_{OUT} = 10V$)

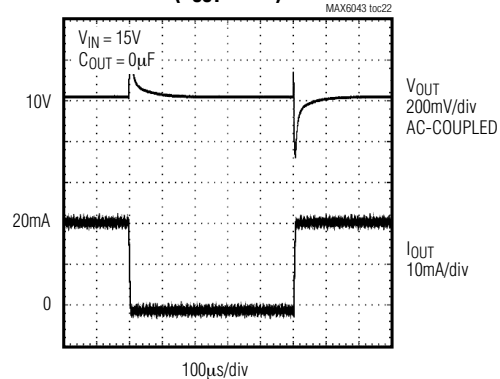

LOAD TRANSIENT
($V_{OUT} = 2.5V$)

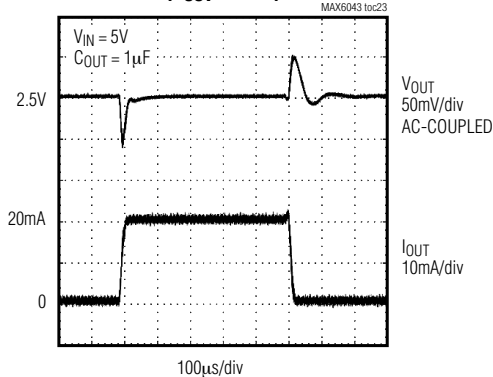

LOAD TRANSIENT
($V_{OUT} = 10V$)

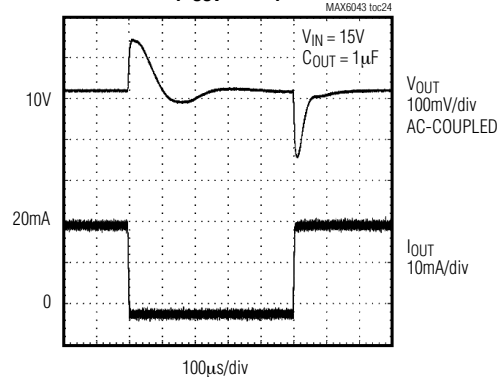

Precision High-Voltage Reference in SOT23

Typical Operating Characteristics (continued)

($V_{IN} = +5V$ for $V_{OUT} = +2.5V$, $V_{IN} = +10V$ for $V_{OUT} = +3.3V$ or $+4.096V$, $V_{IN} = +15V$ for $V_{OUT} = +5V$ or $+10V$, $I_{OUT} = 0$, $T_A = +25^\circ C$, unless otherwise noted.)

**LOAD TRANSIENT
($V_{OUT} = 2.5V$)**

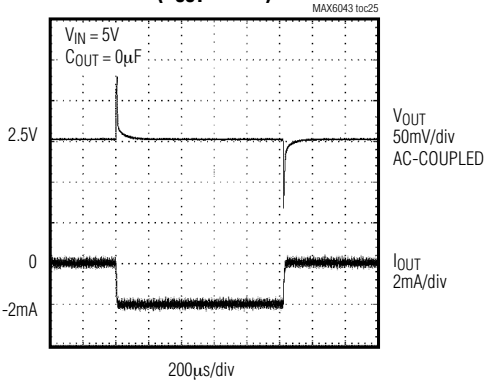

**LOAD TRANSIENT
($V_{OUT} = 10V$)**

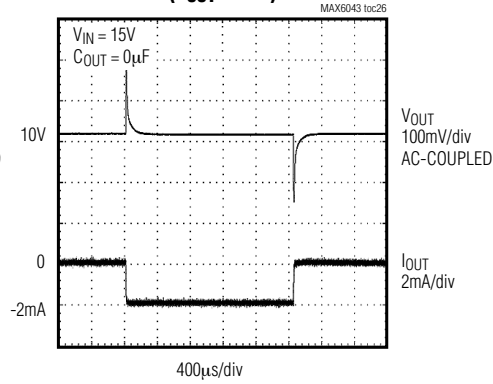

**LOAD TRANSIENT
($V_{OUT} = 2.5V$)**

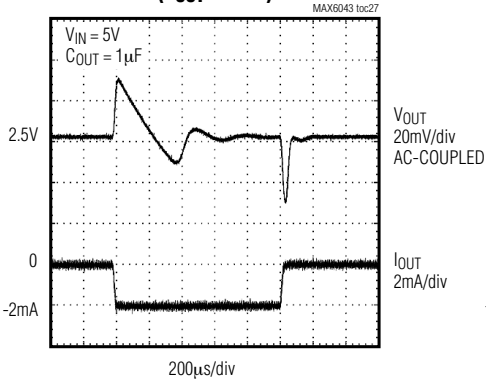

**LOAD TRANSIENT
($V_{OUT} = 10V$)**

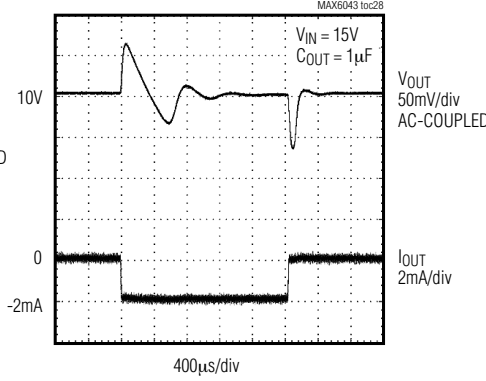

**LINE TRANSIENT
($V_{OUT} = 2.5V$)**

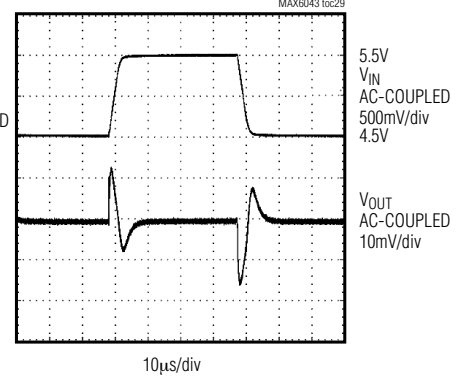

**LINE TRANSIENT
($V_{OUT} = 10V$)**

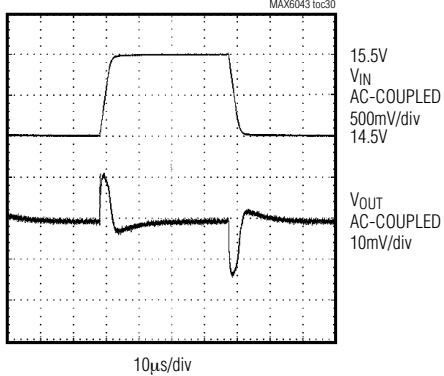

**TURN-ON TRANSIENT
($V_{OUT} = 2.5V$)**

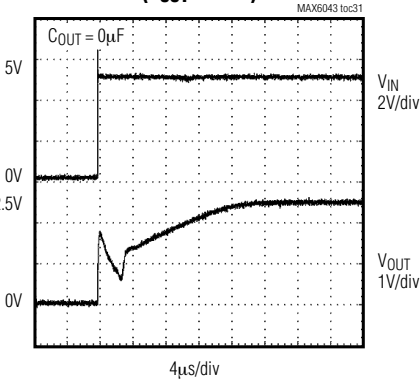

**TURN-ON TRANSIENT
($V_{OUT} = 10V$)**

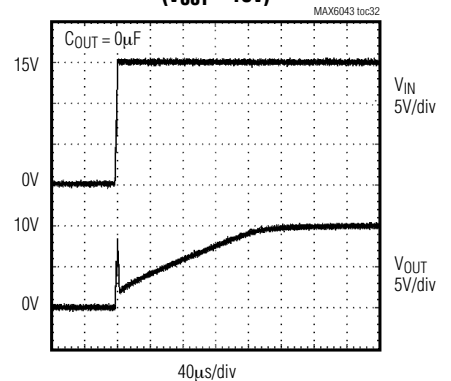

Precision High-Voltage Reference in SOT23

MAX6043

Typical Operating Characteristics (continued)

($V_{IN} = +5V$ for $V_{OUT} = +2.5V$, $V_{IN} = +10V$ for $V_{OUT} = +3.3V$ or $+4.096V$, $V_{IN} = +15V$ for $V_{OUT} = +5V$ or $+10V$, $I_{OUT} = 0$, $T_A = +25^\circ C$, unless otherwise noted.)

TURN-ON TRANSIENT
($V_{OUT} = 2.5V$)

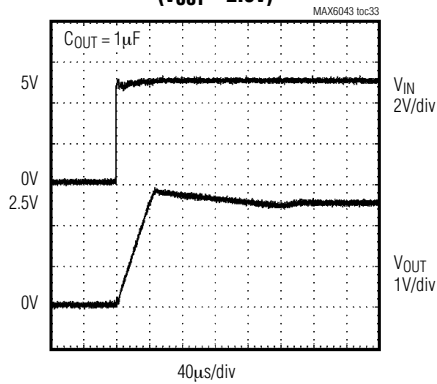

TURN-ON TRANSIENT
($V_{OUT} = 10V$)

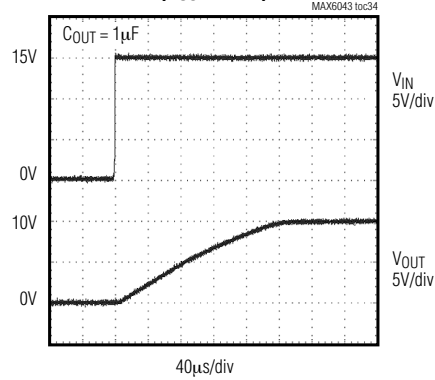

TURN-OFF TRANSIENT
($V_{OUT} = 2.5V$)

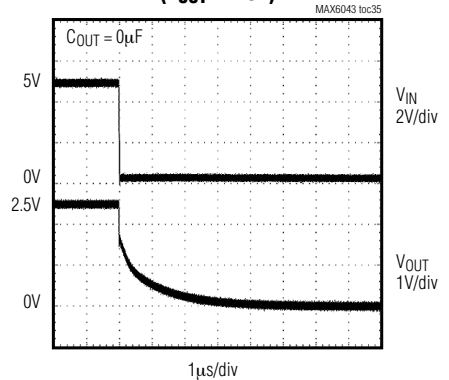

TURN-OFF TRANSIENT
($V_{OUT} = 10V$)

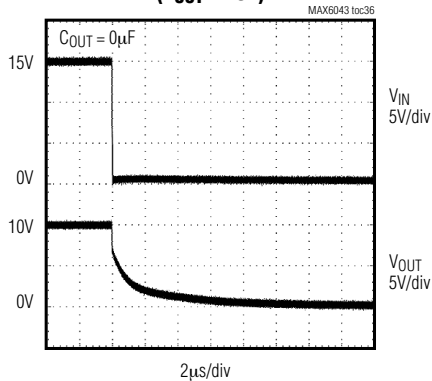

TURN-OFF TRANSIENT
($V_{OUT} = 2.5V$)

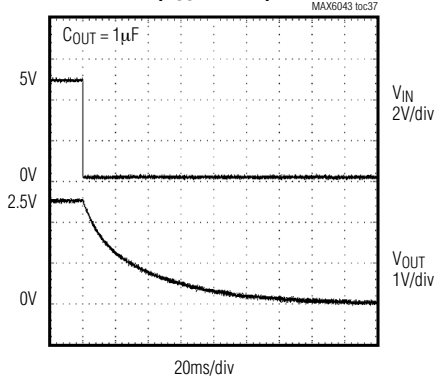

TURN-OFF TRANSIENT

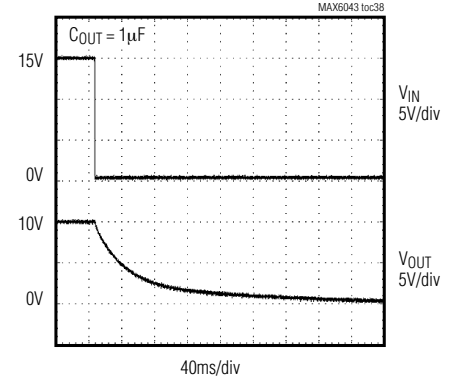

LONG-TERM DRIFT
($V_{OUT} = 2.5V$)

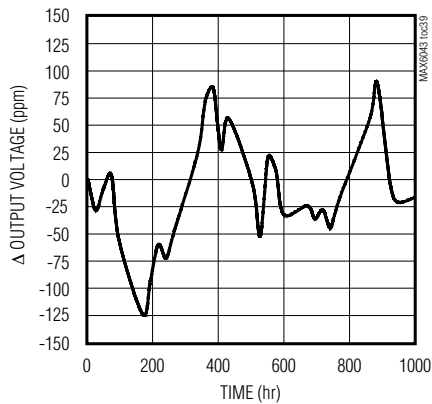

LONG-TERM DRIFT
($V_{OUT} = 10V$)

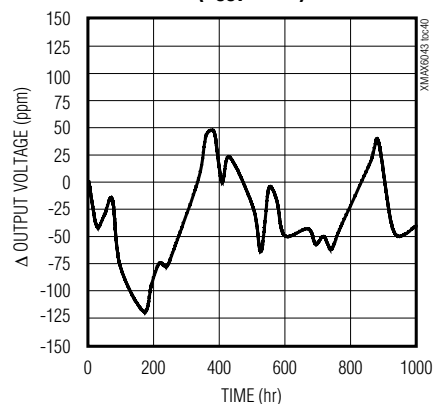

Precision High-Voltage Reference in SOT23

Pin Description

PIN	NAME	FUNCTION
1, 3	I.C.	Internally Connected. Do not connect externally.
2	GND	Ground
4	IN	Positive Power-Supply Input
5	OUTF	Voltage-Reference Force Output. Connect OUTF to OUTS as close to the device as possible. OUTF and OUTS do not require a bypass capacitor for stability.
6	OUTS	Voltage-Reference Sense Input

Applications Information

Bypassing/Output Capacitance

For the best line-transient performance, decouple the input with a 0.1 μ F ceramic capacitor as shown in the *Typical Operating Circuit*. Place the capacitor as close to IN as possible. When transient performance is less important, no capacitor is necessary.

The MAX6043 does not require an output capacitor for stability and is stable with capacitive loads up to 100 μ F. In applications where the load or the supply can experience step changes, a larger output capacitor reduces the amount of overshoot (undershoot) and improves the circuit's transient response. Place output capacitors as close to the device as possible for best performance.

Supply Current

The MAX6043 consumes 320 μ A of quiescent supply current. This improved efficiency reduces power dissipation and extends battery life.

Thermal Hysteresis

Thermal hysteresis is the change in the output voltage at $T_A = +25^\circ\text{C}$ before and after the device is cycled over its entire operating temperature range. Hysteresis is caused by differential package stress appearing across the bandgap core transistors. The typical thermal hysteresis value is 150ppm.

Turn-On Time

The MAX6043 typically turns on and settles to within 0.05% of the preset output voltage in 150 μ s.

Short-Circuited Outputs

The MAX6043 features a short-circuit-protected output. Internal circuitry limits the output current to 60mA when short-circuiting the output.

Temperature Coefficient vs. Operating Temperature Range for a 1 LSB Maximum Error

In a data converter application, the reference voltage of the converter must stay within a certain limit to keep the error in the data converter smaller than the resolution limit through the operating temperature range. Figure 1 shows the maximum allowable reference-voltage temperature coefficient to keep the conversion error to less than 1 LSB, as a function of the operating temperature range ($T_{MAX} - T_{MIN}$) with the converter resolution as a parameter. The graph assumes the reference-voltage temperature coefficient as the only parameter affecting accuracy.

In reality, the absolute static accuracy of a data converter is dependent on the combination of many parameters such as integral nonlinearity, differential nonlinearity, offset error, gain error, as well as voltage-reference changes.

Precision High-Voltage Reference in SOT23

MAX6043

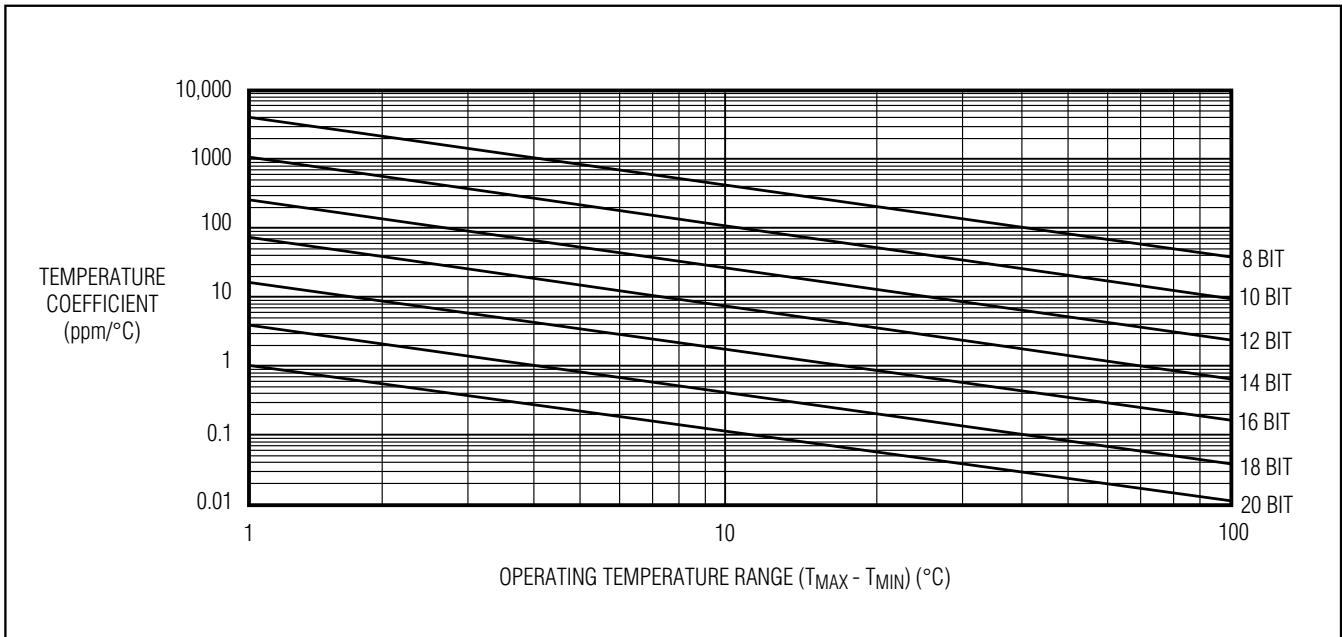

Figure 1. Temperature Coefficient vs. Operating Temperature Range for a 1 LSB Maximum Error

Precision High-Voltage Reference in SOT23

Ordering Information (continued)

PART	TEMP RANGE	PIN-PACKAGE	TOP MARK
MAX6043AAUT33-T	-40°C to +125°C	6 SOT23-6	ABSA
MAX6043BAUT33-T	-40°C to +125°C	6 SOT23-6	ABDS
MAX6043CAUT33-T	-40°C to +125°C	6 SOT23-6	ABDT
MAX6043AAUT41-T	-40°C to +125°C	6 SOT23-6	ABSB
MAX6043BAUT41-T	-40°C to +125°C	6 SOT23-6	ABDU
MAX6043CAUT41-T	-40°C to +125°C	6 SOT23-6	ABDV
MAX6043AAUT50-T	-40°C to +125°C	6 SOT23-6	ABSC
MAX6043BAUT50-T	-40°C to +125°C	6 SOT23-6	ABDW
MAX6043CAUT50-T	-40°C to +125°C	6 SOT23-6	ABDX
MAX6043AAUT10-T	-40°C to +125°C	6 SOT23-6	ABSD
MAX6043BAUT10-T	-40°C to +125°C	6 SOT23-6	ABDY
MAX6043CAUT10-T	-40°C to +125°C	6 SOT23-6	ABDZ

Typical Operating Circuit

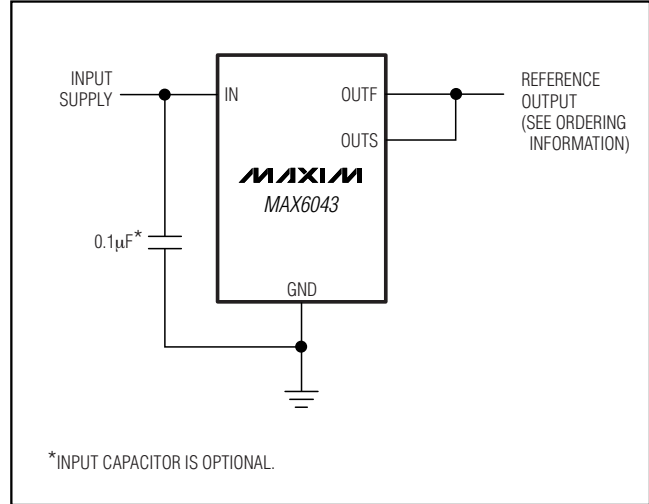

Chip Information

TRANSISTOR COUNT: 152
 PROCESS: BiCMOS

Precision High-Voltage Reference in SOT23

Package Information

(The package drawing(s) in this data sheet may not reflect the most current specifications. For the latest package outline information, go to www.maxim-ic.com/packages.)

MAX6043

SOT23

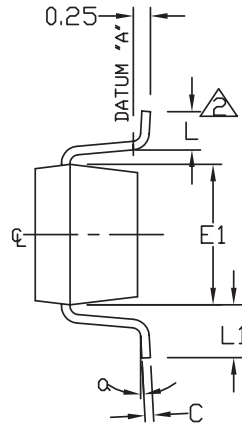
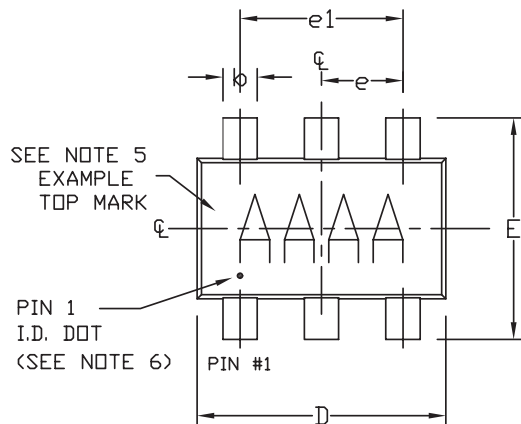

SYMBOL	MIN	MAX
A	0.90	1.45
A1	0.00	0.15
A2	0.90	1.30
b	0.35	0.50
C	0.08	0.20
D	2.80	3.00
E	2.60	3.00
E1	1.50	1.75
L	0.35	0.60
L1	0.60	REF.
e1	1.90	BSC.
e	0.95	BSC.
α	0°	10°

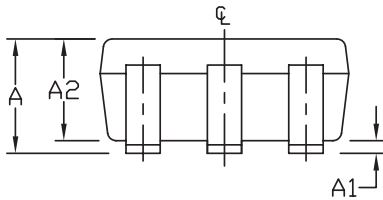

NOTES:

1. ALL DIMENSIONS ARE IN MILLIMETERS.
2. FOOT LENGTH MEASURED AT INTERCEPT POINT BETWEEN DATUM A & LEAD SURFACE.
3. PACKAGE OUTLINE EXCLUSIVE OF MOLD FLASH & METAL BURR. MOLD FLASH, PROTRUSION OR METAL BURR SHOULD NOT EXCEED 0.25 MM.
4. PACKAGE OUTLINE INCLUSIVE OF SOLDER PLATING.
5. PIN 1 IS LOWER LEFT PIN WHEN READING TOP MARK FROM LEFT TO RIGHT. (SEE EXAMPLE TOP MARK)
6. PIN 1 I.D. DOT IS 0.3 MM Ø MIN. LOCATED ABOVE PIN 1.
7. MEETS JEDEC MO178, VARIATION AB.
8. SOLDER THICKNESS MEASURED AT FLAT SECTION OF LEAD BETWEEN 0.08mm AND 0.15mm FROM LEAD TIP.
9. LEAD TO BE COPLANAR WITHIN 0.1 MM.

<small>PROPRIETARY INFORMATION</small>		
<small>TITLE:</small> PACKAGE OUTLINE, SOT-23, 6L		
<small>APPROVAL</small>	<small>DOCUMENT CONTROL NO.</small> 21-0058	<small>REV.</small> F 1/1

Maxim cannot assume responsibility for use of any circuitry other than circuitry entirely embodied in a Maxim product. No circuit patent licenses are implied. Maxim reserves the right to change the circuitry and specifications without notice at any time.

Maxim Integrated Products, 120 San Gabriel Drive, Sunnyvale, CA 94086 408-737-7600 _____ 15