

SMDJ-HRA Series

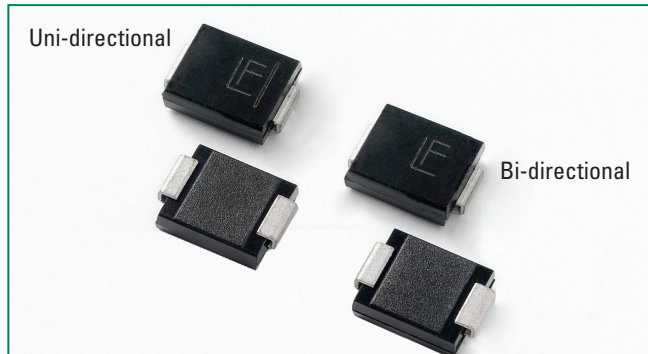

Agency Approvals

| AGENCY | AGENCY FILE NUMBER |
|--------|--------------------|
| | E230531 |

Maximum Ratings and Thermal Characteristics (T_A=25°C unless otherwise noted)

| Parameter | Symbol | Value | Unit |
|--|-----------------------------------|------------|------|
| Peak Pulse Power Dissipation at T _A =25°C by 10/1000µs waveform (Fig.1)(Note 1), (Note 2) | P _{PPM} | 3000 | W |
| Power Dissipation on infinite heat sink at T _A =50°C | P _{M(AV)} | 6.5 | W |
| Peak Forward Surge Current, 8.3ms Single Half Sine Wave (Note 3) | I _{FSM} | 300 | A |
| Maximum Instantaneous Forward Voltage at 100A for Unidirectional only | V _F | 3.5 | V |
| Operating Junction and Storage Temperature Range | T _J , T _{STG} | -65 to 150 | °C |
| Typical Thermal Resistance Junction to Lead | R _{UJL} | 15 | °C/W |
| Typical Thermal Resistance Junction to Ambient | R _{UJA} | 75 | °C/W |

- Notes:**
1. Non-repetitive current pulse, per Fig. 3 and derated above T_A = 25°C per Fig. 2.
 2. Mounted on copper pad area of 0.31x0.31" (8.0 x 8.0mm) to each terminal.
 3. Measured on 8.3ms single half sine wave or equivalent square wave for unidirectional device only, duty cycle=4 per minute maximum.

Functional Diagram

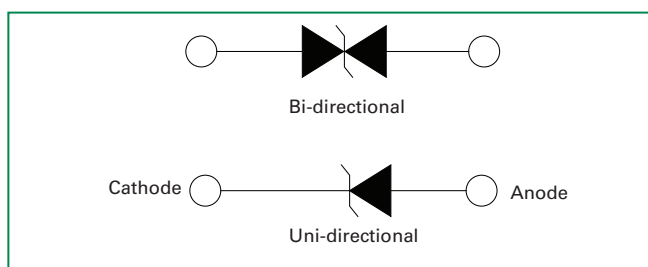

Description

The SMDJ-HRA High Reliability series is designed specifically to protect sensitive electronic equipment from voltage transients induced by lightning and other transient voltage events. These are available with a variety of up-screening options for enhanced reliability.

Features

- 3000W peak pulse power capability at 10/1000µs waveform, repetition rate (duty cycles):0.01 %
- High reliability devices with fabrication and assembly lots traceability
- Enhanced reliability screening options are available in reference to MIL-PRF-19500. Refer to screen process table for more detail on screening options
- For surface mounted applications in order to optimize board space
- Low profile package
- Built-in strain relief
- V_{BR} @ T_J = V_{BR} @ 25°C x (1 + α T x (T_J - 25)) (α T: Temperature Coefficient, typical value is 0.1 %)
- Glass passivated chip junction
- Very fast response time
- Excellent clamping capability
- Low incremental surge resistance
- Typical I_R less than 2µA above 12V
- High Temperature soldering guaranteed: 260°C/10 seconds at terminals
- Plastic package is flammability rated V-0 per UL 94
- Meet MSL level1, per J-STD-020, LF maximum peak of 260°C
- Matte tin lead-free plated
- Halogen free and RoHS compliant
- Pb-free E3 means 2nd level interconnect is Pb-free and the terminal finish material is tin(Sn) (IPC/ JEDEC J-STD-609A.01)

Applications

SMDJ-HRA devices are ideal for the high reliability protection of I/O Interfaces, V_{CC} bus and other vulnerable circuits used in Telecom, Computer, Industrial and Consumer electronic applications.

Electrical Characteristics

| Part Number (Uni) | Part Number (Bi) | Marking | | Reverse Stand off Voltage V_R (Volts) | Breakdown Voltage V_{BR} (Volts) @ I_T | | Test Current I_T (mA) | Maximum Clamping Voltage V_C @ I_{PP} (V) | Maximum Peak Pulse Current I_{PP} (A) | Maximum Reverse Leakage I_R @ V_R (μ A) | Agency Approval  |
|-------------------|------------------|---------|------|---|--|--------|-------------------------|---|---|--|---|
| | | UNI | BI | | MIN | MAX | | | | | |
| SMDJ5.0A-HRA | SMDJ5.0CA-HRA | RDEH | DDEH | 5.0 | 6.40 | 7.00 | 10 | 9.2 | 326.1 | 800 | X |
| SMDJ6.0A-HRA | SMDJ6.0CA-HRA | RDGH | DDGH | 6.0 | 6.67 | 7.37 | 10 | 10.3 | 291.3 | 800 | X |
| SMDJ6.5A-HRA | SMDJ6.5CA-HRA | RDKH | DDKH | 6.5 | 7.22 | 7.98 | 10 | 11.2 | 267.9 | 500 | X |
| SMDJ7.0A-HRA | SMDJ7.0CA-HRA | PDMH | DDMH | 7.0 | 7.78 | 8.60 | 10 | 12.0 | 250.0 | 200 | X |
| SMDJ7.5A-HRA | SMDJ7.5CA-HRA | PDPH | DDPH | 7.5 | 8.33 | 9.21 | 1 | 12.9 | 232.6 | 100 | X |
| SMDJ8.0A-HRA | SMDJ8.0CA-HRA | PDRH | DDRH | 8.0 | 8.89 | 9.83 | 1 | 13.6 | 220.6 | 50 | X |
| SMDJ8.5A-HRA | SMDJ8.5CA-HRA | PDTH | DDTH | 8.5 | 9.44 | 10.40 | 1 | 14.4 | 208.3 | 20 | X |
| SMDJ9.0A-HRA | SMDJ9.0CA-HRA | PDVH | DDVH | 9.0 | 10.00 | 11.10 | 1 | 15.4 | 194.8 | 10 | X |
| SMDJ10A-HRA | SMDJ10CA-HRA | PDXH | DDXH | 10.0 | 11.10 | 12.30 | 1 | 17.0 | 176.5 | 5 | X |
| SMDJ11A-HRA | SMDJ11CA-HRA | PDZH | DDZH | 11.0 | 12.20 | 13.50 | 1 | 18.2 | 164.8 | 2 | X |
| SMDJ12A-HRA | SMDJ12CA-HRA | PEEH | DEEH | 12.0 | 13.30 | 14.70 | 1 | 19.9 | 150.8 | 2 | X |
| SMDJ13A-HRA | SMDJ13CA-HRA | PEGH | DEGH | 13.0 | 14.40 | 15.90 | 1 | 21.5 | 139.5 | 2 | X |
| SMDJ14A-HRA | SMDJ14CA-HRA | PEKH | DEKH | 14.0 | 15.60 | 17.20 | 1 | 23.2 | 129.3 | 2 | X |
| SMDJ15A-HRA | SMDJ15CA-HRA | PEMH | DEMH | 15.0 | 16.70 | 18.50 | 1 | 24.4 | 123.0 | 2 | X |
| SMDJ16A-HRA | SMDJ16CA-HRA | PEPH | DEPH | 16.0 | 17.80 | 19.70 | 1 | 26.0 | 115.4 | 2 | X |
| SMDJ17A-HRA | SMDJ17CA-HRA | PERH | DERH | 17.0 | 18.90 | 20.90 | 1 | 27.6 | 108.7 | 2 | X |
| SMDJ18A-HRA | SMDJ18CA-HRA | PETH | DETH | 18.0 | 20.00 | 22.10 | 1 | 29.2 | 102.7 | 2 | X |
| SMDJ20A-HRA | SMDJ20CA-HRA | PEVH | DEVH | 20.0 | 22.20 | 24.50 | 1 | 32.4 | 92.6 | 2 | X |
| SMDJ22A-HRA | SMDJ22CA-HRA | PEXH | DEXH | 22.0 | 24.40 | 26.90 | 1 | 35.5 | 84.5 | 2 | X |
| SMDJ24A-HRA | SMDJ24CA-HRA | PEZH | DEZH | 24.0 | 26.70 | 29.50 | 1 | 38.9 | 77.1 | 2 | X |
| SMDJ26A-HRA | SMDJ26CA-HRA | PFEH | DFEH | 26.0 | 28.90 | 31.90 | 1 | 42.1 | 71.3 | 2 | X |
| SMDJ28A-HRA | SMDJ28CA-HRA | PFGH | DFGH | 28.0 | 31.10 | 34.40 | 1 | 45.4 | 66.1 | 2 | X |
| SMDJ30A-HRA | SMDJ30CA-HRA | PFKH | DFKH | 30.0 | 33.30 | 36.80 | 1 | 48.4 | 62.0 | 2 | X |
| SMDJ33A-HRA | SMDJ33CA-HRA | PFMH | DFMH | 33.0 | 36.70 | 40.60 | 1 | 53.3 | 56.3 | 2 | X |
| SMDJ36A-HRA | SMDJ36CA-HRA | PFPH | DFPH | 36.0 | 40.00 | 44.20 | 1 | 58.1 | 51.6 | 2 | X |
| SMDJ40A-HRA | SMDJ40CA-HRA | PFRH | DFRH | 40.0 | 44.40 | 49.10 | 1 | 64.5 | 46.5 | 2 | X |
| SMDJ43A-HRA | SMDJ43CA-HRA | PFTH | DFTH | 43.0 | 47.80 | 52.80 | 1 | 69.4 | 43.2 | 2 | X |
| SMDJ45A-HRA | SMDJ45CA-HRA | PFVH | DFVH | 45.0 | 50.00 | 55.30 | 1 | 72.7 | 41.3 | 2 | X |
| SMDJ48A-HRA | SMDJ48CA-HRA | PFXH | DFXH | 48.0 | 53.30 | 58.90 | 1 | 77.4 | 38.8 | 2 | X |
| SMDJ51A-HRA | SMDJ51CA-HRA | PFZH | DFZH | 51.0 | 56.70 | 62.70 | 1 | 82.4 | 36.4 | 2 | X |
| SMDJ54A-HRA | SMDJ54CA-HRA | RGEH | DGEH | 54.0 | 60.00 | 66.30 | 1 | 87.1 | 34.4 | 2 | X |
| SMDJ58A-HRA | | PGGH | | 58.0 | 64.40 | 71.20 | 1 | 93.6 | 32.1 | 2 | X |
| SMDJ60A-HRA | | PGKH | | 60.0 | 66.70 | 73.70 | 1 | 96.8 | 31.0 | 2 | X |
| SMDJ64A-HRA | | PGMH | | 64.0 | 71.10 | 78.60 | 1 | 103.0 | 29.1 | 2 | X |
| SMDJ70A-HRA | | PGPH | | 70.0 | 77.80 | 86.00 | 1 | 113.0 | 26.5 | 2 | X |
| SMDJ75A-HRA | | PGRH | | 75.0 | 83.30 | 92.10 | 1 | 121.0 | 24.8 | 2 | X |
| SMDJ78A-HRA | | PGTH | | 78.0 | 86.70 | 95.80 | 1 | 126.0 | 23.8 | 2 | X |
| SMDJ85A-HRA | | PGVH | | 85.0 | 94.40 | 104.00 | 1 | 137.0 | 21.9 | 2 | X |
| SMDJ90A-HRA | | PGXH | | 90.0 | 100.00 | 111.00 | 1 | 146.0 | 20.5 | 2 | X |
| SMDJ100A-HRA | | PGZH | | 100.0 | 111.00 | 123.00 | 1 | 162.0 | 18.5 | 2 | X |
| SMDJ110A-HRA | | PHEH | | 110.0 | 122.00 | 135.00 | 1 | 177.0 | 16.9 | 2 | X |
| SMDJ120A-HRA | | PHGH | | 120.0 | 133.00 | 147.00 | 1 | 193.0 | 15.5 | 2 | X |
| SMDJ130A-HRA | | PHKH | | 130.0 | 144.00 | 159.00 | 1 | 209.0 | 14.4 | 2 | X |

Note:

1. For bidirectional type having V_R of 10 volts and less, the I_R limit is double.
2. SMDJ-HRA voltage binning can be specified by customer's request via contacting Littelfuse service

Screen Process

| | |
|--|-----------------------------------|
| 100% Vision Inspection | MIL-STD-750 method 2074 |
| 100% High Temperature Storage Life (168hrs,175°C) | MIL-STD-750 method 1031 |
| 100% X-RAY inspection | MIL-STD-750 method 2076 |
| 100% Temperature Cycle Test (-55 to150°C, 20 cycles, dwell time 15 min) | MIL-STD-750 method 1051 |
| 100% Reflow (2X) | JEDEC J-STD-020 |
| 100% Surge Test (2x) | MIL-STD-750 method 4066 |
| 100% HTRB 150°C Bias=VR(80% breakdown voltage, 96hrs, and each direction 96hrs for Bi-directional products) | MIL-STD-750 method 1038 |
| Final Electrical Test(100% 3 sigma limit, 100% dynamic test and PAT limit) | MIL-STD-750 method 4016.4021.4011 |

Note: Up-screen program can be specified by customer's request via contacting Littelfuse service

I-V Curve Characteristics

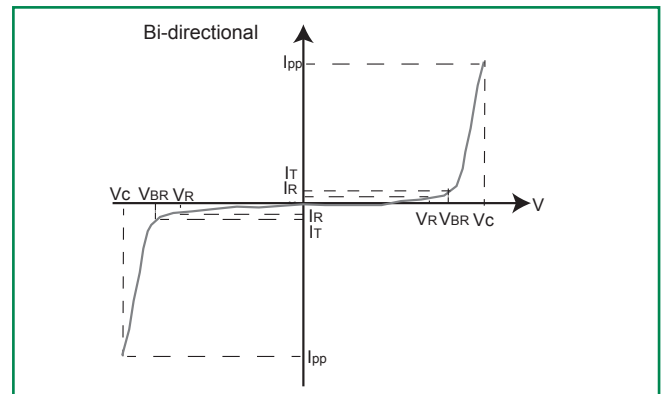
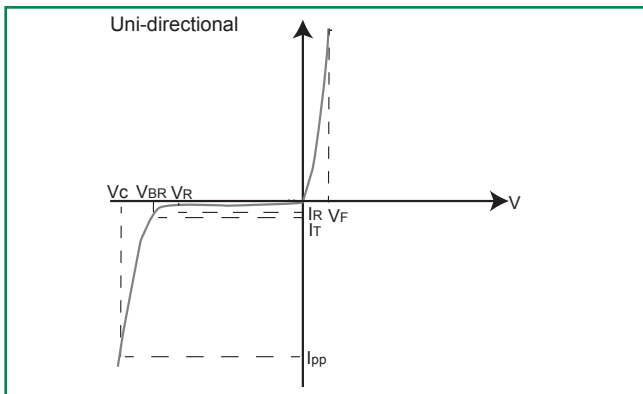

- P_{PPM} Peak Pulse Power Dissipation** – Max power dissipation
- V_R Stand-off Voltage** – Maximum voltage that can be applied to the TVS without operation
- V_{BR} Breakdown Voltage** – Maximum voltage that flows though the TVS at a specified test current (I_T)
- V_C Clamping Voltage** – Peak voltage measured across the suppressor at a specified I_{ppm} (peak impulse current)
- I_R Reverse Leakage Current** – Current measured at V_R
- V_F Forward Voltage Drop for Uni-directional**

Ratings and Characteristic Curves ($T_A=25^\circ\text{C}$ unless otherwise noted)

Figure 1 - TVS Transients Clamping Waveform

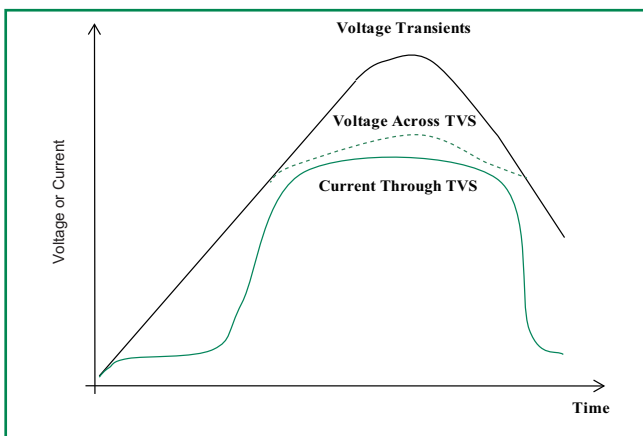
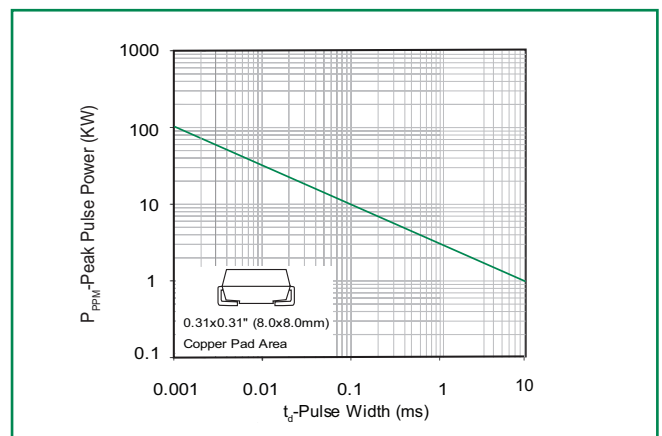

Figure 2 - Peak Pulse Power Rating



Ratings and Characteristic Curves ($T_A=25^\circ\text{C}$ unless otherwise noted) (Continued)

Figure 3 - Pulse Derating Curve

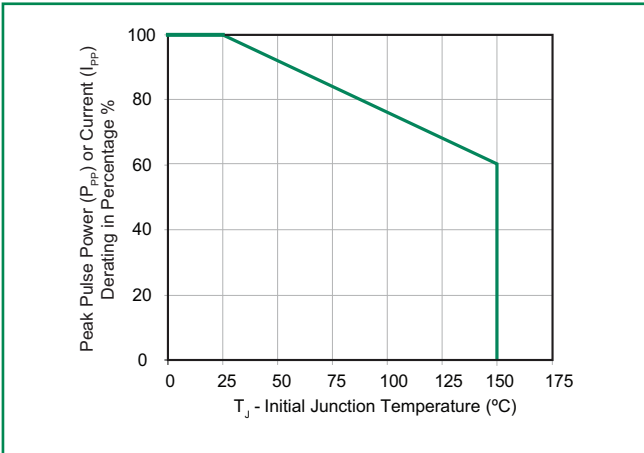

Figure 4 - Pulse Waveform

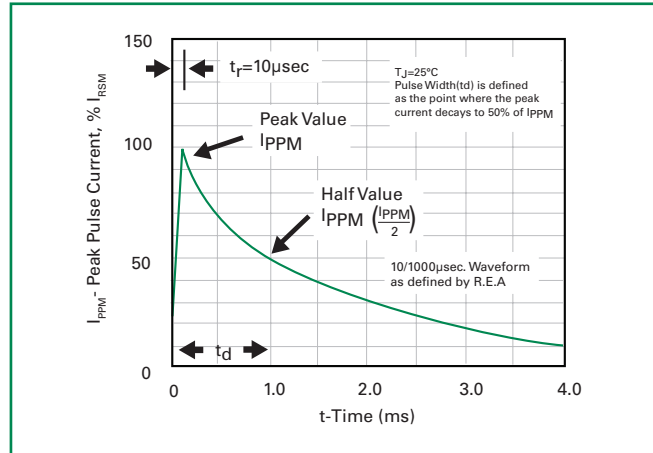

Figure 5 - Typical Junction Capacitance

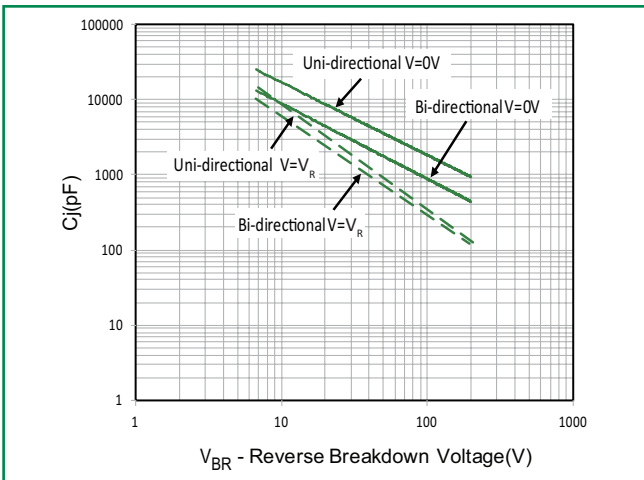

Figure 6 - Steady State Power Derating Curve

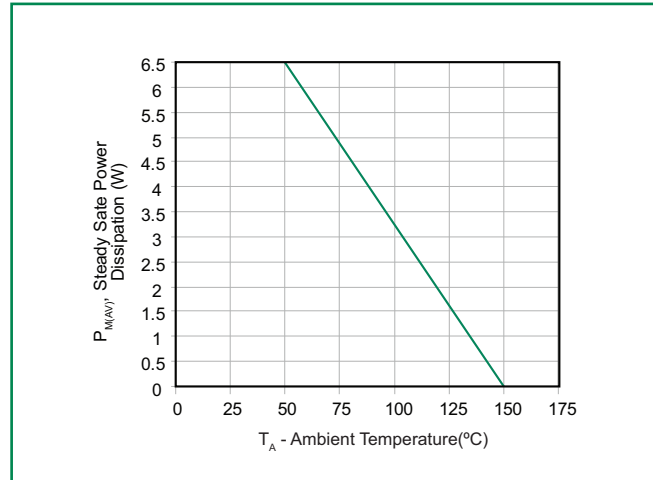
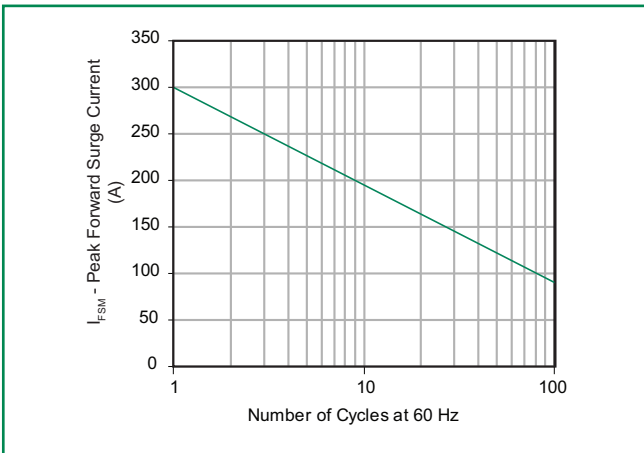
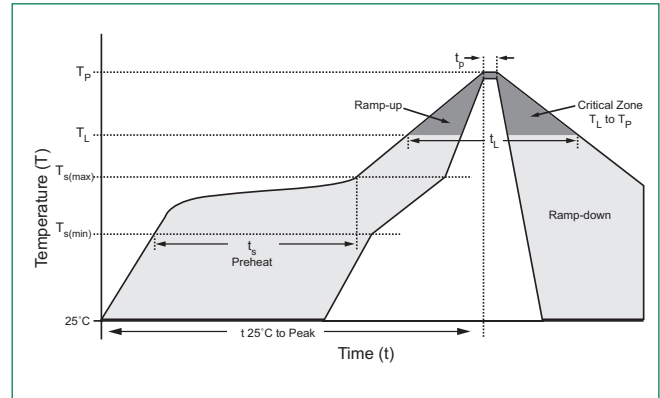

Figure 7 - Maximum Non-Repetitive Peak Forward Surge Current Uni-Directional only



Soldering Parameters

| | | |
|--|------------------------------------|-------------------------|
| Reflow Condition | | Lead-free assembly |
| Pre Heat | - Temperature Min ($T_{s(min)}$) | 150°C |
| | - Temperature Max ($T_{s(max)}$) | 200°C |
| | - Time (min to max) (t_s) | 60 – 180 secs |
| Average ramp up rate (Liquidus Temp (T_L) to peak) | | 3°C/second max |
| $T_{S(max)}$ to T_L - Ramp-up Rate | | 3°C/second max |
| Reflow | - Temperature (T_L) (Liquidus) | 217°C |
| | - Time (min to max) (t_s) | 60 – 150 seconds |
| Peak Temperature (T_p) | | 260 ^{+0/-5} °C |
| Time within 5°C of actual peak Temperature (t_p) | | 20 – 40 seconds |
| Ramp-down Rate | | 6°C/second max |
| Time 25°C to peak Temperature (T_p) | | 8 minutes Max. |
| Do not exceed | | 260°C |



Physical Specifications

| | |
|-----------------|---|
| Weight | 0.007 ounce, 0.21 grams |
| Case | JEDEC DO214AB. Molded plastic body over glass passivated junction |
| Polarity | Color band denotes positive end (cathode) except Bidirectional. |
| Terminal | Matte Tin-plated leads, Solderable per JESD22-B102 |

Environmental Specifications

| | |
|----------------------------|--------------------------|
| High Temp. Storage | JESD22-A103 |
| HTRB | JESD22-A108 |
| Temperature Cycling | JESD22-A104 |
| MSL | JEDEC-J-STD-020, Level 1 |
| H3TRB | JESD22-A101 |
| RSH | JESD22-A111 |

Dimensions

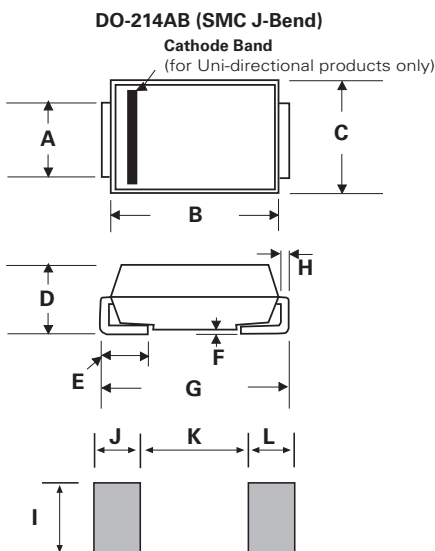

| Dimensions | Inches | | Millimeters | |
|------------|--------|-------|-------------|-------|
| | Min | Max | Min | Max |
| A | 0.114 | 0.126 | 2.900 | 3.200 |
| B | 0.260 | 0.280 | 6.600 | 7.110 |
| C | 0.220 | 0.245 | 5.590 | 6.220 |
| D | 0.079 | 0.103 | 2.060 | 2.620 |
| E | 0.030 | 0.060 | 0.760 | 1.520 |
| F | 0.002 | 0.008 | 0.051 | 0.203 |
| G | 0.305 | 0.320 | 7.750 | 8.130 |
| H | 0.006 | 0.012 | 0.152 | 0.305 |
| I | 0.129 | - | 3.300 | - |
| J | 0.094 | - | 2.400 | - |
| K | - | 0.165 | - | 4.200 |
| L | 0.094 | - | 2.400 | - |

Part Numbering System

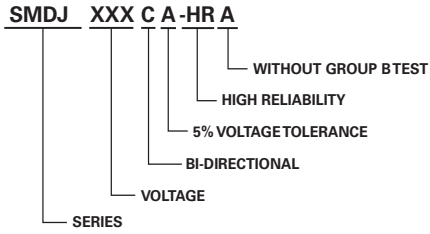

Part Marking System

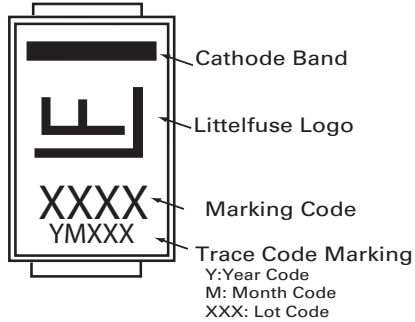

Packaging

| Part number | Component Package | Quantity | Packaging Option | Packaging Specification |
|-----------------|-------------------|----------|-----------------------------------|-------------------------|
| SMDJxxxXX-HRA | DO-214AB | 3000 | Tape & Reel – 16mm tape /13" reel | EIA STD RS-481 |
| SMDJxxxXX-HRAT7 | DO-214AB | 500 | Tape & Reel – 16mm tape/7" reel | EIA STD RS-481 |

Tape and Reel Specification

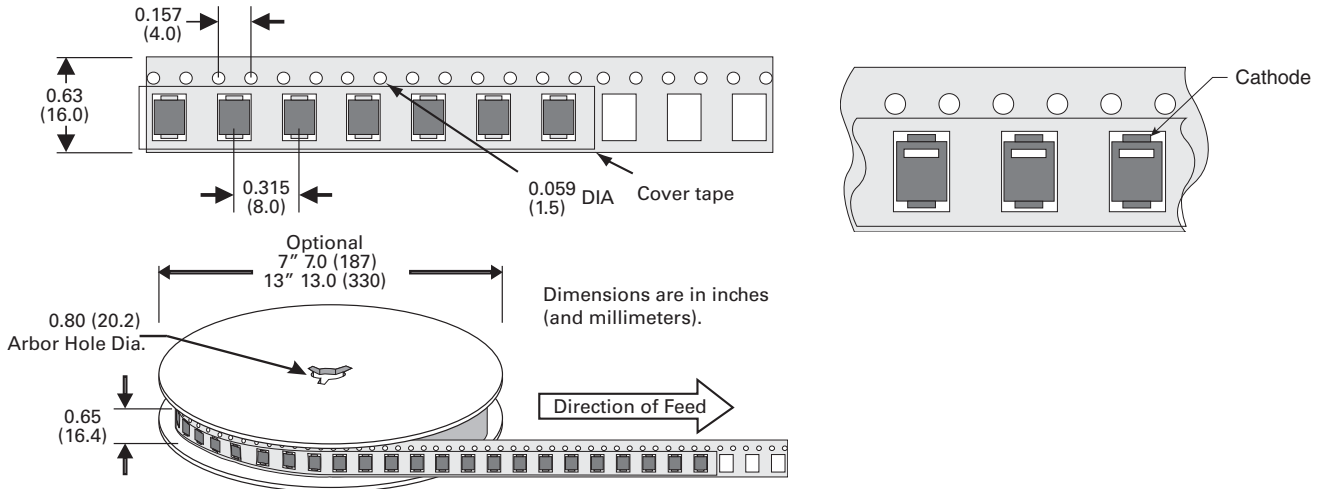

RTCA/DO-160G Wave 3

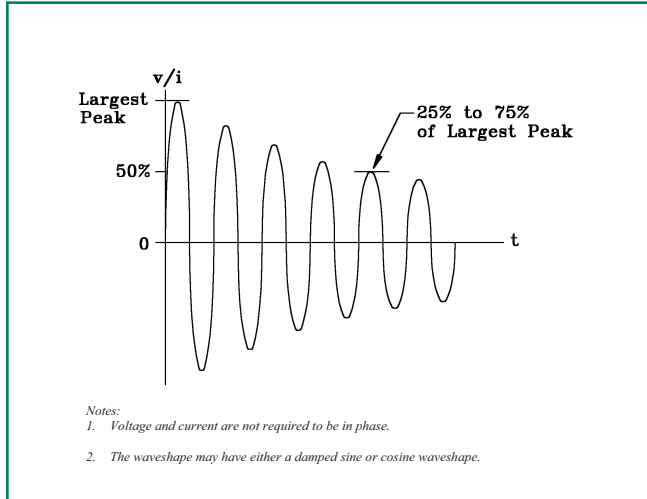

RTCA/DO-160G Wave 4

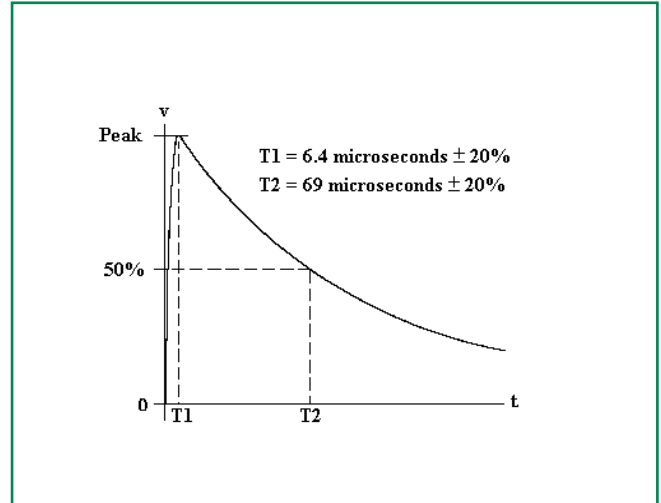

RTCA/DO-160G Wave 4 and Wave 5

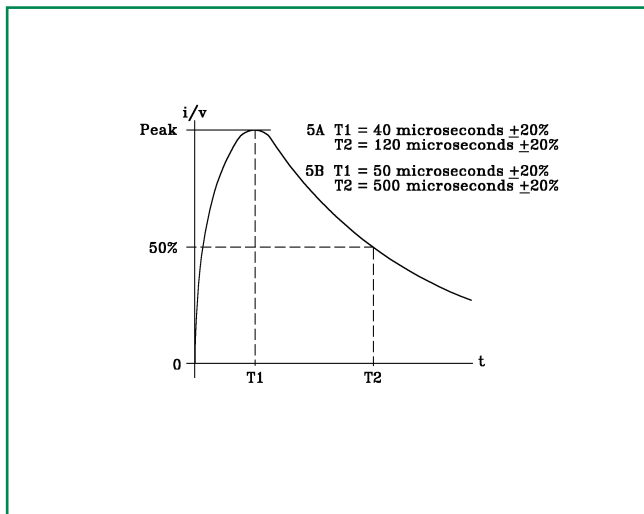

Pin Injection Protection Per RTCA/DO-160G

| Part Number (Uni) | Part Number (Bi) | 25C | | | | | | 70C | | | | | | 120C | | | | | |
|-------------------|------------------|--------|------|-------------------|------|------|--------------------|--------|------|-------------------|------|------|--------------------|--------|------|-------------------|------|------|--------------------|
| | | Wave 3 | | Wave 4 (6.4/69us) | | | Wave 5a (40/120us) | Wave 3 | | Wave 4 (6.4/69us) | | | Wave 5a (40/120us) | Wave 3 | | Wave 4 (6.4/69us) | | | Wave 5a (40/120us) |
| | | L5 | L3 | L4 | L5 | L3 | L4 | L5 | L3 | L4 | L5 | L3 | L4 | L5 | L3 | L4 | L5 | L3 | L4 |
| | | 128A | 60A | 150A | 320A | 300A | 750A | 128A | 60A | 150A | 320A | 300A | 750A | 128A | 60A | 150A | 320A | 300A | 750A |
| SMDJ5.0A-HRA | SMDJ5.0CA-HRA | pass | pass | pass | pass | pass | pass | pass | pass | pass | pass | pass | pass | pass | pass | pass | pass | pass | pass |
| SMDJ6.0A-HRA | SMDJ6.0CA-HRA | pass | pass | pass | pass | pass | pass | pass | pass | pass | pass | pass | pass | pass | pass | pass | pass | pass | pass |
| SMDJ6.5A-HRA | SMDJ6.5CA-HRA | pass | pass | pass | pass | pass | pass | pass | pass | pass | pass | pass | pass | pass | pass | pass | pass | pass | - |
| SMDJ7.0A-HRA | SMDJ7.0CA-HRA | pass | pass | pass | pass | pass | pass | pass | pass | pass | pass | pass | pass | - | pass | pass | pass | pass | pass |
| SMDJ7.5A-HRA | SMDJ7.5CA-HRA | pass | pass | pass | pass | pass | pass | pass | pass | pass | pass | pass | pass | - | pass | pass | pass | pass | pass |
| SMDJ8.0A-HRA | SMDJ8.0CA-HRA | pass | pass | pass | pass | pass | pass | pass | pass | pass | pass | pass | pass | - | pass | pass | pass | pass | pass |
| SMDJ8.5A-HRA | SMDJ8.5CA-HRA | pass | pass | pass | pass | pass | pass | pass | pass | pass | pass | pass | pass | - | pass | pass | pass | pass | pass |
| SMDJ9.0A-HRA | SMDJ9.0CA-HRA | pass | pass | pass | pass | pass | pass | pass | pass | pass | pass | pass | pass | - | pass | pass | pass | pass | pass |
| SMDJ10A-HRA | SMDJ10CA-HRA | pass | pass | pass | pass | pass | pass | pass | pass | pass | pass | pass | pass | - | pass | pass | pass | pass | pass |
| SMDJ11A-HRA | SMDJ11CA-HRA | pass | pass | pass | pass | pass | pass | - | pass | pass | pass | pass | pass | pass | - | pass | pass | pass | pass |
| SMDJ12A-HRA | SMDJ12CA-HRA | pass | pass | pass | pass | pass | pass | - | pass | pass | pass | pass | pass | pass | - | pass | pass | pass | pass |
| SMDJ13A-HRA | SMDJ13CA-HRA | pass | pass | pass | pass | pass | pass | - | pass | pass | pass | pass | pass | pass | - | pass | pass | pass | pass |
| SMDJ14A-HRA | SMDJ14CA-HRA | pass | pass | pass | pass | pass | pass | - | pass | pass | pass | pass | pass | pass | - | pass | pass | pass | pass |
| SMDJ15A-HRA | SMDJ15CA-HRA | pass | pass | pass | pass | pass | pass | - | pass | pass | pass | pass | pass | pass | - | pass | pass | pass | pass |
| SMDJ16A-HRA | SMDJ16CA-HRA | pass | pass | pass | pass | pass | pass | - | pass | pass | pass | pass | pass | - | pass | pass | pass | pass | pass |
| SMDJ17A-HRA | SMDJ17CA-HRA | pass | pass | pass | pass | pass | pass | - | pass | pass | pass | pass | pass | - | pass | pass | pass | pass | pass |
| SMDJ18A-HRA | SMDJ18CA-HRA | pass | pass | pass | pass | pass | pass | - | pass | pass | pass | pass | pass | - | pass | pass | pass | pass | pass |
| SMDJ20A-HRA | SMDJ20CA-HRA | pass | pass | pass | pass | pass | pass | - | pass | pass | pass | pass | pass | - | pass | pass | pass | pass | pass |
| SMDJ22A-HRA | SMDJ22CA-HRA | pass | pass | pass | pass | pass | pass | - | pass | pass | pass | pass | pass | - | pass | pass | pass | pass | pass |
| SMDJ24A-HRA | SMDJ24CA-HRA | pass | pass | pass | pass | pass | pass | - | pass | pass | pass | pass | pass | - | pass | pass | pass | pass | pass |
| SMDJ26A-HRA | SMDJ26CA-HRA | pass | pass | pass | pass | pass | pass | - | pass | pass | pass | pass | pass | - | pass | pass | pass | pass | pass |
| SMDJ28A-HRA | SMDJ28CA-HRA | pass | pass | pass | pass | pass | pass | - | pass | pass | pass | pass | pass | - | pass | pass | pass | pass | pass |
| SMDJ30A-HRA | SMDJ30CA-HRA | pass | pass | pass | pass | pass | pass | - | pass | pass | pass | pass | pass | - | pass | pass | pass | pass | pass |
| SMDJ33A-HRA | SMDJ33CA-HRA | pass | pass | pass | pass | pass | pass | - | pass | pass | pass | pass | pass | - | pass | pass | pass | pass | pass |
| SMDJ36A-HRA | SMDJ36CA-HRA | pass | pass | pass | pass | pass | pass | - | pass | pass | pass | pass | pass | - | pass | pass | pass | pass | pass |
| SMDJ40A-HRA | SMDJ40CA-HRA | pass | pass | pass | pass | pass | pass | - | pass | pass | pass | pass | pass | - | pass | pass | pass | pass | pass |
| SMDJ43A-HRA | SMDJ43CA-HRA | pass | pass | pass | pass | pass | pass | - | pass | pass | pass | pass | pass | - | pass | pass | pass | pass | pass |
| SMDJ45A-HRA | SMDJ45CA-HRA | pass | pass | pass | pass | pass | pass | - | pass | pass | pass | pass | pass | - | pass | pass | pass | pass | pass |
| SMDJ48A-HRA | SMDJ48CA-HRA | pass | pass | pass | pass | pass | pass | - | pass | pass | pass | pass | pass | - | pass | pass | pass | pass | pass |
| SMDJ51A-HRA | SMDJ51CA-HRA | pass | pass | pass | pass | pass | pass | - | pass | pass | pass | pass | pass | - | pass | pass | pass | pass | pass |
| SMDJ54A-HRA | SMDJ54CA-HRA | pass | pass | pass | pass | pass | pass | - | pass | pass | pass | pass | pass | - | pass | pass | pass | pass | pass |
| SMDJ58A-HRA | | pass | pass | - | - | - | - | pass | pass | - | - | - | - | pass | pass | - | - | - | - |
| SMDJ60A-HRA | | pass | pass | - | - | - | - | pass | pass | - | - | - | - | pass | pass | - | - | - | - |
| SMDJ64A-HRA | | pass | pass | - | - | - | - | pass | pass | - | - | - | - | pass | - | - | - | - | - |
| SMDJ70A-HRA | | pass | pass | - | - | - | - | pass | pass | - | - | - | - | pass | - | - | - | - | - |
| SMDJ75A-HRA | | pass | pass | - | - | - | - | pass | pass | - | - | - | - | pass | - | - | - | - | - |
| SMDJ78A-HRA | | pass | pass | - | - | - | - | pass | pass | - | - | - | - | pass | - | - | - | - | - |
| SMDJ85A-HRA | | pass | pass | - | - | - | - | pass | pass | - | - | - | - | pass | - | - | - | - | - |
| SMDJ90A-HRA | | pass | pass | - | - | - | - | pass | pass | - | - | - | - | pass | - | - | - | - | - |
| SMDJ100A-HRA | | pass | pass | - | - | - | - | pass | pass | - | - | - | - | pass | - | - | - | - | - |
| SMDJ110A-HRA | | pass | pass | - | - | - | - | pass | pass | - | - | - | - | pass | - | - | - | - | - |
| SMDJ120A-HRA | | pass | pass | - | - | - | - | pass | pass | - | - | - | - | pass | - | - | - | - | - |
| SMDJ130A-HRA | | pass | pass | - | - | - | - | pass | pass | - | - | - | - | pass | - | - | - | - | - |

Note:

1. L1 = Level1, L2 = Level 2, L3 = Level 3, L4 = Level 4, L5 = Level 5